

"Towards an Earth-Moon Economy - Developing Off-Planet Resources"

Moon Miners' Manifesto

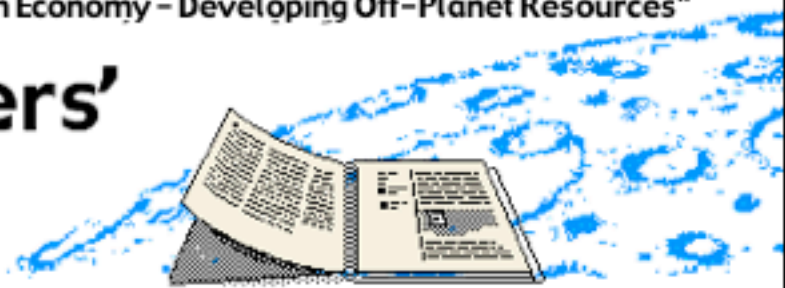

www.MMM-MoonMinersManifesto.com

MMM Classic Themes

Governance & Legal Issues

We, People of Luna, do Declare



National Parks

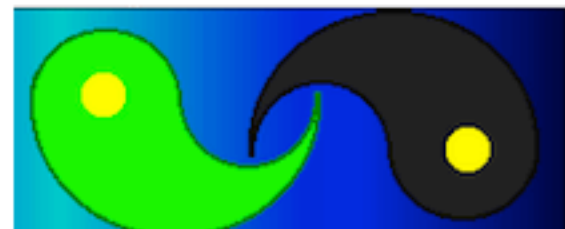
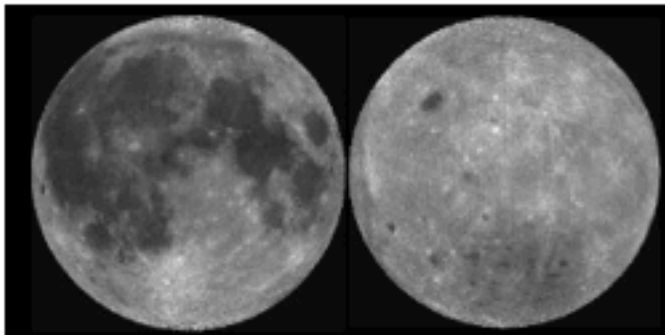
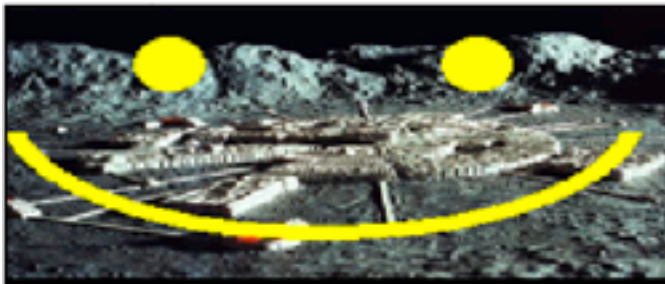

As the Moon's population and economic development grows, self-rule will come!

INDEX MMM THEMES: Governance, Economy, and Legal Issues

- MMM #2 M is for Market; M is for Metropolis
- MMM #32 The Import/Export Equation; Diversification vs. Subsidies
- MMM #39 Moon Mining and Common Eco-Sense; Moon Mining & Engineering Realities
- MMM #47 Native Born
- MMM #52 Xititech
- MMM #102 The Grand Archives of Earth and Humanity
- MMM #109 Luna City Streets
- MMM #128 Defining Home Rule for Settlers
- MMM #129 The HomeRule Question: A Pre-Settlement Charter for the Moon; Efficiency Goals & Tests: Balance of Trade Questions
- MMM #130 A Bill of Rights for Space Frontier Constitutions; A Century on Antarctica: what have we got?
- MMM #131 A Right of Repatriation?; Settlement as Intentional Community; Luna City: The Developer's Role
- MMM #134 Political Independence for Settlements; An Ardent Rebuttal
- MMM #170 Harbor & Town
- MMM #176 National Parks on the Moon
- MMM #224 An International Lunar Research Park
- MMM #249 Lunar Materials to Grow Earth Economy
- MMM #254 Antarctica as a model for International Moon and Mars Outposts
- MMM #255 In Focus: Advocates of Moon and Mars Settlements should work to amend the Antarctic Treaty; Antarctic Activities can Blaze the Trail for Pioneers on Moon and Mars; Working within the Strictures of the Current Antarctic Treaty
- MMM #256 Antarctic Cottage Industries based on "Found" Objects and Materials

THEME THREAD INDEX: LEGAL ISSUES

Standards for Home Rule – Autonomy – Lunar Independence

- MMM #32 The Import/Export Equation; Diversification vs. Subsidies
- MMM #128 Defining Home Rule for Settlers
- MMM #129 The HomeRule Question: A Pre-Settlement Charter for the Moon; Efficiency Goals & Tests: Balance of Trade Questions
- MMM #130 A Bill of Rights for Space Frontier Constitutions
- MMM #134 Political Independence for Settlements; An Ardent Rebuttal

Other Signs of Frontier Maturity

- MMM #47 Native Born
- MMM #52 Xititech
- MMM #102 The Grand Archives of Earth and Humanity
- MMM #109 Luna City Streets
- MMM #131 A Right of Repatriation?; Settlement as Intentional Community; Luna City: The Developer's Role
- MMM #170 Harbor & Town

Legal Precedents & First Steps

MMM #39 Moon Mining and Common Eco-Sense; Moon Mining & Engineering Realities
MMM #130 A Bill of Rights for Space Frontier Constitutions;
MMM #176 National Parks on the Moon
MMM #224 An International Lunar Research Park

A Critical look at Antarctic Precedents

MMM #130 A Century on Antarctica: what have we got?
MMM #254 Antarctica as a model for International Moon and Mars Outposts
MMM #255 In Focus: Advocates of Moon and Mars Settlements should work to amend the Antarctic Treaty; Antarctic Activities can Blaze the Trail for Pioneers on Moon and Mars; Working within the Strictures of the Current Antarctic Treaty
MMM #256 Antarctic Cottage Industries based on "Found" Objects and Materials

MMM #2

M IS FOR MARKET:

The customary "prospectus" for the Moon is that it will be a major, or the major, supplier of liquid oxygen to low Earth orbit depots and of raw ores to L5 colonies or "Space Settlements" where it will be turned into metal alloy components of more space colonies and solar power satellites, the slag left over being used for shielding. Really, this depends on where people actually choose to live, how big the lunar settlement becomes, and whether it chooses to deliver low value raw materials or higher price value-added processed materials and / or finished goods. The assumption that the great bulk of manufacturing will be done at L5 rather than on the Moon on the grounds that humans cannot tolerate 1/6th G for long is an untested, unproven, unwarranted, and gratuitous opinion. There is enough room, enough of a market, and enough volunteers for both kinds of settlements. The rivalry between L5 colonies and the Moon will be both healthy and productive.

LUNOX Corporation, selling liquid oxygen to the various low Earth orbit (LEO) space stations and staging depots, probably in exchange for equal volumes of liquid hydrogen (nitrogen, ammonia, methane will also be needed) may well be the Moon's first employer. But current writing shows lack of imagination. Raw materials from the Moon can be processed into many things that can be sold and delivered to LEO at great cost advantage, e.g. modules and trusses of the space station itself, windows and glassware, ceramic table ware, fiberglass insulation and fabrics, tools and instruments, some furniture items, and so on. And all of these items will find a market in GEO (Earth synchronous orbit) and L5 as well. LUNOX will supply oxygen not only as fuel oxidizer but as the major component of water and the breathable component of air. Even food items grown on the Moon with "supported" hydrogen, carbon, and nitrogen are still about 50% lunar oxygen and can be delivered to LEO, GEO, and L5 more cheaply from the Moon than from the Earth.

Even the heavy parts of satellites might better be made on the Moon to be mated with the lighter "works" in an LEO or L1 station. The hulls for ships to take men to Mars might better be made on the Moon, and on and on and on. The day may come when competition from the Moon restricts Earth-bound aerospace giants to producing high value light weight components that require materials that are not abundant on the Moon, e.g. copper, gold, platinum, silver, tin, niobium, hydrocarbon plastics, etc.

Yes, the markets are there, and the Moon can pay its way!

M IS FOR METROPOLIS:

It has been estimated that it takes a community of about 250,000 minimum to provide all the various goods and services in a diversified economy to be substantially independent of imports. When anyone speaks of their belief that a Lunar or Martian settlement of a few hundred persons can be autonomous, they are either being naive or are defining autonomy loosely. Such a small settlement might achieve 50–60% self-sufficiency, but a metropolis of a quarter million could be 95% self-sufficient. No wooden nickels, please! Let's go for broke or quit kidding ourselves. MMM

MMM #32

The Import/Export Equation

IMPORT / EXPORT
↓ ↖ ↗
EQUATION

Part VI: TO SURVIVE, PRINCETON MUST EARN MORE IN EXPORTS THAN IT PAYS FOR IMPORTS

Peter Kokh

A. Settlement Import Categories And Strategies to Cut and/or Avoid Them

1. **CAPITOL EQUIPMENT:** "MUS/cle" co-manufacture is easily the most promising approach. A minimal sintered iron and glass composite manufacturing capacity must be imported FIRST. Thereafter, complex lightweight electronics-rich ("cle") "works packages" from Earth are mated to Massive Unitary Simple ("MUS") parts made on the Moon of Lunar materials and assembled on the site to make additional equipment for Energy Generation, Mining & Processing, Manufacturing, Construction, Fabrication & Repair, and for Food Production. [cf.: "M.U.S./C.L.E." in MMM # 18 September '88.]
- 2-**SETTLERS:** "Bantamweights" will do. For Prinztion will be run with brains rather than brawn. Weight savings on settlers can be applied elsewhere.
- 3-**FARM PLANTS AND ANIMALS:** Seeds only, and worms and bee colonies; Seeds packed in hot pure N₂ to kill hitchhiking pests; Unpatented non-hybrid cultivars only; and pregnant female animals only.
- 4-**VOLATILES:** Hydrogen, Carbon, Nitrogen: The import burden can be softened by some careful measures faithfully pursued:
 - (a) Harvesting, by heating, of the significant quantities of H, C, N, and other gases adsorbed to the fine regolith particles, thanks to eons of bombardment by the Solar Wind, during all those construction processes involving soil moving;
 - (b) (Out-sourcing to gravity wells shallower than Earth's e.g. Phobos and Deimos, Earth-approaching asteroids and comets;
 - (c) (Conservation of volatile-rich organic materials by religiously thorough recycling efforts. In support of this goal Prinztion will need "kosher" (organics not bonded to inorganics) knock-down- friendly ("KD") assembly methods; systematically thorough and foolproof sorting clues and handy routing managements; and above all the help of ingrained second-nature good habits and expected chore assignments.
 - (d) 'Pre-codesigning' of all single-use containers for volume-matched secondary more durable uses. (An example already attempted was the elusive "World Bottle" design i.e. a bottle that could be reused as a brick; Effort not yet successful.) (e) Buttoning up pressurized areas for Nitrogen conservation by use of novel airlock systems: Matchlock "intergates" to allow suitless shirtsleeve transfer between vehicles and habitat areas; Liquid airlocks for some freight categories such as goods manufactured inside for use in vacuum and vice versa; and

Turtle-back spacesuits that back into special mated airlocks for direct entry from suit to habitat and vice versa.

5-RARE METALS: An elegant way to painlessly "co-import" rare metals, and even some synthetics is by making all needed shipping containers end packaging out of such materials i.e. the easily forgotten category of "Tare". [Gross - Net = Tare] Making this standard practice could provide a tidy "cheap" endowment of badly needed materials hard to process from the Lunar soil such as copper, brass, other precious metals, other needed alloying ingredients, and even some volatiles in the form of lightly polymerized synthetics. Crates, Boxes, Barrels, Tanks, Cans, Bottles, and packing stuffing and dividers could all be made of such strategic materials.

6-HABITATS: To make the Prinztion construction camp, an original minimum number of tight-packed space station module type sardine cans can be followed by locally manufactured and constructed Big Dumb Volume Structures in which are placed "Works Core Modules" made on Earth. Such cores would contain Kitchen/Bath facility, electrical service, communications-entertainment center, air conditioning-heating-cleaning unit, etcetera. The total core package would be lighter (no massive hull) and cheaper to upport from Earth and the host habitat would be much more spacious and cabin-fever resistant. Such Works Core Modules, but with an ever greater Made-on- Luna "MUS/cle" content, also serves in Prinztion's Village Homes.

7-NON SELF-MANUFACTURED GOODS: For those needed and desired items Prinztionians need but are not yet capable of providing for themselves, the "MUS/cle" formula is again part of the answer. But substituting metal, glass, Glax* [composites], and ceramics wherever possible for wood and plastics, and doing without wherever this is impractical must be Plan A. Mail order catalogs from Earth will be taboo and instead items from the hands of local artists and craftsmen will be treasured. A paperless all electronic society will be a top priority goal. [cf: "Paper Chase", MMM # 4 April 1987, republished in MMMC #1.]

B-Strategies to Lower Import Costs and/or Increase Import Quantities

1-ALTERNATE SOURCES: Prinztion will need to import considerable quantities of hydrogen, carbon and nitrogen, most easily handled in the form of methane CH₄ and ammonia NH₃. Discounting the amortizable capital costs of emplacing the needed equipment, these volatiles can be shipped at a fraction of the total fuel cost, from Phobos or Deimos, moons of Mars, at regular 26 month intervals. Such shallower gravity well sources also include occasional catch-as-catch-can Earth-approaching asteroids, comets, and wildcat-worthy inactive comet-hulks. The Moon's deficiency is the Solar System's gain. For settlers will have a do-or-die urgency in pioneering such markets.

2-LOWERING COST-OFF-EARTH will be above all a matter of developing (at last!) more economical surface-to-orbit launch systems. But our crafty settlers will also attempt to lower prices FOB Earth by buying goods on favorable terms Solar Power Satellite customer nations. **3-LOWERING COST-ONTO-MOON.** Unlike both Earth and Mars, the Moon has no handy atmosphere to allow aerobrake assistance. But there are other more inventive alternatives to full retrobraking. These may include skid-landing on prepared regolith smoothways. [Lunar Bases and Space Activities of the 21st Century, W.W. Mendell Ed.r, Lunar & Planetary Institute, Houston 1985 pp. 848-50 "The Lunar Slide Lander" by Kraft A. Ehricke] and the "Edportation" scheme of Chicago inventor Ed Marwick. Passengers may not line up for such wild rides, but drone "sliders" could bring in needed bulk materials and other hardy cargoes.

C-LUNAR EXPORT CATEGORIES

- 1 – **BULK MATERIALS:** Liquid Oxygen; Regolith for shielding; Enriched ores for space processing.
- 2 – **OXYGEN CONTAINING PRODUCTS** such as Water and Foodstuffs cheaper than from Earth even if they contain terrestrial Hydrogen and Carbon.
- 3 – **BUILDING MATERIALS AND COMPONENTS:** Iron and Steel; Aluminum, Titanium, Magnesium alloy; Glass and Glass–Glass Composites; Ceramics & Concrete.
- 4 – **ITEMS MANUFACTURED ON THE MOON** to cut imports are also marketable to LEO, GEO, L5, Mars Ph/D (Phobos, Deimos): Furniture and furnishings; Tanks, Holds, Appliance Cases, other items.

D–EXPORT DESTINATIONS

Low Earth orbit Space Stations and other manned facilities, Space Colony Oases at L4/L5 or in other orbits, and Mars–bound expeditions are all Markets for Lunar Lox, Food, Water, building materials products, and sundry finished goods all Lunar or MUS/cle assembly). Geosynchronous orbit is a destination for large multi–satellite capacity platforms and Solar Power Satellites.

E–STRATEGIES TO INCREASE EXPORTS

1–LOWERING EXPORT LAUNCH & DELIVERY COSTS: Mass Drivers, Bucket, and Pods should be upgraded to launch more profitable value–added goods.. 1st Upgrade: enriched beneficiated ores: Fe, FeO, TiO, Al₂O₃, CaO, MgO, SiO; Batch–loads of glass matrix, glass fiber, and cement. Second Upgrade: right–sized ingots: Fe, Al, Ti, Mg. 3rd Upgrade: shock–proofed pods of small manufactured parts. In addition, goods bound for Earth's surface could be shipped in no–transfer self–contained Earth–aerobrake–and–Land "dynasoar" capsules.

2–INCREASING MARKET DEMAND:

Liquid Oxygen: Would–be–Prinztonians should push development of "Stage Plus" Earth Deep–Space Launchers designed for on–orbit LOX refueling. Food deliveries to LEO stations and other space locales, will depend on selection, delivery, marketing.

Building Materials: Lunar Owned Space Architecture and Space Construction Firms will channel a greater share of space construction profits back to the Settlement. Promotion of the 1/6th G lunar Gravity as a Standard for rotating space structures will mean quicker more frequent sales because the rotation rate linked minimum size and mass of such structures will be an order of magnitude smaller, a more attainable threshold.

Prinzton made Consumer Goods can be promoted along with Lunar–type material culture in general as the appropriate norm for near Earth facilities in the era of still expensive volatiles. Such goods involve material substitutions and a high profile for Art/Craft made wares.

Promotion of the Moon as the "Hub" of the ETM (extra–terrestrial materials) economy will be an essential settler policy. Their do–or–die motivation and proven know–how will drive Lunar–initiated market development of Mars and its moons, and of the Asteroids. Key here may be the development of Minimal Mobile Biospheres. The larger deep–space long–cruising vessels have to be to hold self–contained mini–biospheres, the greater the obstacle to opening the asteroids.

3–MARKET TARGETING: Logical Earth Trading Partners for Prinzton are those nations which are at once

- Energy Importing Countries (Solar Power Satellite sales, Helium–3 sales) and
- Sources of elements not economically Lunar–sourceable yet strategic to Prinzton development.

Many of these countries are in the "Urban Tropics."

4-MAXIMIZING TOURIST INCOME.

The lure to well-heeled sightseers can be intensified in several ways.

A "**Seven Wonders**" list, carefully drawn up and publicized, and a variety of enticing itineraries will encourage repeat trips or at least longer stays.

Special ways to taste the settler way of life can be offered to visitors.

- Stays in lunar homes
- Working tours
- Art & Craft classes
- Special tours e.g. of factories and recycling systems, and
- The opportunity to actually participate in unique Lunan sports.

Customs regulations can entice tourists to trade all their Earth garb (for Lunar Stage/Theater Use) in exchange for souvenir Made-on-Luna apparel.

Shopping Spree Tours for unique arts, craft, and clothing pieces at the Settlements cottage industry flea markets should be marketed.

5-TELEVISION & FILM MEDIA SALES:

Advertising Revenues could be appreciable enough to wholly finance:

- Development of Unique Lunan Spectator Sports, which in turn could be televised to Earth audiences hungry for something new and exotic.
- Construction of any facilities such sports may require
- The same goes for the "ethereal" Prinztan Ballet Company, probably awaiting the coming of age of the first native-born generation.
- Documentaries about Prinztan and Lunar activities at large will vie with space adventure films for the use of the Out Of This World film studio in Prinztan.

6-EXPORTING KNOW-HOW:

Technology transfer is a potential money-maker for Prinztan. Hopefully much of the technology needed to make Prinztan a thriving reality will have been pre-developed for profitable terrestrial applications and thus served to keep Prinztan's up front costs far lower than they otherwise could be. But enterprising young Prinztanians will develop new products and processes salable Greenside. **MMM**



Diversification vs. Subsidies

Peter Kokh

≠ **EXPORTS** We have outlined a very ambitious picture of what a mature Prinztan economy might look like.

- **IMPORTS** But what is the logical order in which such a well-rounded economy might be best achieved?

BOTTOM LINE Diversification will depend on some things that we cannot accurately forecast at his time:

- **Size of the LEO market for LOX, building materials, other manufactured and processed goods**
- **Progress in opening up space markets elsewhere, e.g. Phobos/Deimos etc.**

Different scenarios can be plotted assuming various values for these unknowns. We can list some very pertinent questions, however. Their answers will greatly affect the strategy and game plan chosen.

For each industry proposed for Prinztion, we will want to know the following:

- (1) What is the industry's capacity to generate export tonnage? () Major - () Medium - () Minor
- (2) What is the industry's capacity to defray import tonnage? () Major - () Medium - () Minor
- (3) What is the export value-added per tonne? () Major - () Medium - () Minor
- (4) To what degree is the industry labor-intensive? () Major - () Medium - () Minor
- (5) To what degree is the industry energy-intensive? () Major - () Medium - () Minor
- (6) What is the industry's pressurized acreage need? () Major - () Medium - () Minor
- (7) How well can the industry's operations be separated into successive diurnal (dayspan) energy-intensive vs. nocturnal (nightspace) labor-intensive portions? () Major - () Medium - () Minor
- (8) How much heat is needed for operation? () Low - () Medium - () High
- (9) How much heat is generated by operation? () Low - () Medium - () High
- (10) What is the industry's need for vacuum? () Major - () Medium - () Minor
- (11) What percentage of chemical reagents used can be recycled? () Major - () Medium - () Minor
- (12 a) To what extent can the industry be set up in modular units so that production capacity can be easily increased as needed? () Major - () Medium - () Minor
- (12 b) How high is the import tonnage of each module in terms of economic gains? () Major - () Medium - () Minor
- (12 c) To what extent can MUS/cle* co-manufacturing savings be applied to additional modules needed?
[* see the article from MMM #18 in MMMC 2, pp. 34-35] () Major - () Medium - () Minor
- (13) What prior industrial material byproducts are presupposed? () Major - () Medium - () Minor
- (14) What prior processing capacities are presupposed? () Major - () Medium - () Minor
- (15) What subsequent industries are enabled by new byproducts generated? () Many - () Few - () None
- (16) What subsequent industries are enabled by processing capacities offered? () Many - () Few - () None
- (17) How "ready-to-go" is the technology for operation in Lunar Conditions? () Little - () Partly - () Go!

Once we've done our homework on these and similarly relevant questions, we will be ready to begin a serious discussion of long-term Lunar Industrialization Plans

MMM

MMM #39

MOON MINING & COMMON ECO-SENSE

By Peter Kokh

The multi-thousand-year-long record of human mining activities on our home planet will surely be enough to convince even the most bribe-prone galactic bureaucrat to deny us required permits to extend such resource extraction efforts off-planet. In default of such red tape, it is left up to us to judge and police ourselves.

With mines come huge ugly piles of useless barren tailings and scarred landscapes slow to heal, streams poisoned with acid run-off, and legions of workers with dust-racked lungs. The record gives pause to those considering opening up pristine eco-vulnerable Antarctica for development of its legendary mineral wealth. Should it not also give pause to those who look with such high expectations to the plains and rolling highlands of our serene gray neighbor, the Moon?

The salient points to remember are these:

- (1) The Moon's mineral endowment has been minimally differentiated or locally concentrated and is thus distributed rather homogeneously, by Earth comparisons, in ores that are extremely poor by our standards. There will be no reason to fight over deposits or jump another's claim.
- (2) There is no reason to believe that richer deposits lie buried deep beneath the already pulverized regolith blanket that covers the entire surface to a depth of some 2-5 meters. In effect, countless ancient meteorites by their bombardment have already "pre-mined" the surface for us. There is no need for open pit mining.
- (3) As to what does lie deeper, the central peaks of the larger craters represent upthrust material from several kilometers below – sample and source enough should we need it. There will be no need to deep tunnel the Moon.
- (4) In the absence of atmosphere, any and all dust 'kicked-up' by our various activities, has nothing to suspend it above the surface, and is quickly purged from the near-surface vacuum by the Moon's light but effective 1/6th gravity.
- (5) Tailings, the unwanted residue after resource extraction, will be visibly indistinguishable from the source material. Tailing mounds will blend in with the moonscape, and if preferable, can be raked back over the surface. The only clue to an area's having been mined will be a telltale absence of minor craterlets. Tailings should usually be minimal, nonetheless, since more than one resource will be extracted leaving little more than the proverbial squeal of the pig.
[See "Tailings" in MMM # 23 March '89 – republished in MMM Classics #3]
- (6) Fluids and gases used in the extraction process such as water, hydrogen, hydrofluoric acid, chlorine etc. must be brought from Earth at great expense. So resource extraction cannot possibly be accomplished economically unless ways are found to recover and recycle these reagents almost totally (read 99%). There will be no mass leachate drainage into the environment.
- (7) Even in the case of accidental spills of reagent leachings, there is no lunar ground water to pollute or spread the problem. Spills will remain localized and it will be an economic imperative to recover as much as possible. (
- (8) Miners, if you can call them that, will not be breathing atmosphere in contact with the regolith they are processing. Health concerns will instead focus on minimizing accidents and exposure to cosmic rays and rare solar flares.
- (9) As to housekeeping activities of miners themselves in their shielded habitat warrens, they too must recycle and conserve religiously [see "Saving Money on food in Space" – elsewhere in this issue]. They will assuredly be acutely aware that living immediately "downwind" and "downstream" of themselves in cradling mini-biospheres leaves scant room for eco-carelessness.

As long as private enterprise – carrying the baggage of the almighty "bottom line" – is the agent in question, you can rest assured that sheer economic necessity will work mightily to prevent 'eco-nonsense' on the Moon. The real danger would come with government leadership and its deferrable accountability.

When you hear or read someone express alarm at prospects for developing the Moon, remember these points. A good response with this as with any challenge: "That's just what I used to think – until I looked into the matter further!"

MMM

MOON MINING & ENGINEERING REALITIES

By Peter Kokh

In an article in the June 1990 issue of the **Engineering and Mining Journal** with the title **"Moon Mining: should we boldly mine where no one has ever mined before?"**

Earl C. Herkenhoff, P.E. raises several points about the very logic of moon-mining. His tone is blatantly hostile.

The writer's principal point is that (to his knowledge) our survey of the Moon's mineral wealth is so incomplete that it is highly premature to be discussing what we can or cannot extract from it, and certainly premature to be spending hard scarce cash on studies as to how to go about doing it.

Our response is that while admittedly our mineralogical survey is far from complete, the wide equatorial swath 'read' by orbiting gamma ray spectrometers on board Apollo Command Modules the last three missions, coupled with the six widely scattered diverse surface sites actually sampled by our astronauts and the three additional sites sampled by the automated Soviet sample-retrieving missions, gives us high confidence that what we've seen and sampled is representative of the Moon at large.

Herkenhoff insults NASA geologists and their carefully supervised astronaut proxies when he speaks scornfully of "only a few pounds of

✓ "grab samples" "snatched" from the surface of the Moon

✓ at only "a tiny spot" on the surface where the landing craft was set down."

It's clear that the writer hasn't gone even the first mile in trying to objectively understand what we were trying to accomplish during Apollo.

The granted exception to this is the absence of sampling and orbital readings near the lunar poles leaves open the possibility that permashade cold traps in deep near-pole craters may contain volatile resources which have been ruled out elsewhere. On this very point, vis-a-vis the possibility of finding water, the writer betrays his shallow study of published lunar findings by speculating that more thorough prospecting might find hydrates as fixed water in igneous rocks. To the contrary, we are now quite certain that the Moon formed hot and dry and that none of its volcanoes or fissures spouted any steam and that its great lava outpourings were also quite dry.

The writer shoots his respectability in the foot when on the one hand he complains that our exploration has not been thorough enough, and on the other he states correctly that the Moon is 'unlikely to contain minerals that have been concentrated by magmatic segregation'. When he states that 'it is a safe bet that most minerals are complex silicates' he isn't telling us any thing that we don't already know quite well.

He also shows the shallowness of his science background when he doubts out loud how we can be so sure that Solar-Wind-derived Helium-3 is more than a local quirk in the few tiny soil samples studied. Surely there is no mechanism by which the Solar Wind could have deposited its largess in anything but an indiscriminate way!

Herkenhoff complains that established mining companies have not been consulted about mining methods – after he has already slipped and told us that they wouldn't dream of trying to extract anything useful from such miserably low grade ores. "Even on Earth, process hydro-metallurgists would flinch at such an assignment." In point of fact, established companies have been too busy getting wealthy off of Earth's much richer ores to have bothered to accumulate any know-how that might apply to the situation facing us on the Moon. What

would be the point in listening to those whose predictable broken-record message is "it can't be done"? We have no choice but to seek out rebels willing to try something new.

He points to the difficulty miners will face in working in vacuum and without abundant water – surely not news to us! We have to pioneer not only whole new chemical extraction processes but engineer new ways of handling the raw materials involved. You have to grant him a sharp touché', however, when he asks how we can ever hope to do anything so difficult, when NASA can't seem to get even simple things straight these days.

Certainly no one should underestimate the engineering and chemical processing difficulties ahead of us. Unfortunately, most space advocates betray in their butt-to-the-sofa fixed positions just such a naive grasp of the situation. We have a fearsome amount of homework to do. NASA is not doing it, and NSS seems to assume it will just all fall into place somehow. SSI by itself can only scratch the surface with the member-derived funds it has to work with.

Perhaps it is this all too nonchalant cocky conviction that we display in our bold scenarios for the future that encourages this open scorn. Our dreams of the future may turn out to be on target, but if we continue to rely on nothing more than let-George-do-it [i.e. the government] "activism", how will we ever know?

Herkenhoff lists an impressive bibliography. It is mute testimony that he has done his homework with prior bias in search of ammunition. [

Nb. Thanks to R. McNeil of the Willey Ley Space Society, the Chattanooga, Tennessee NSS chapter, for bringing this article to MMM's attention!]

MMM #47

Native Born



We can't wait to see if the Moon is "safe for children."

**Until we're sure that the 2nd native generation is healthy and fertile, we won't know.
Delay will be self-defeating.**

By Peter Kokh

In the recently ABC-aired Disney movie about a pioneer lunar mining settlement, "Plymouth", the central drama was the emergency dilemma of whether to return a pregnant pioneer to Earth, risking the unborn fetus in a high-G descent, or to allow her to bear a child on the Moon that might never be able to survive on Earth. Indeed, birth of the first human offspring outside the womb-world (Birth Squared!) will be a momentous milestone, easily eclipsing any mere demonstration of hardware and technology. If we are to build a system-faring civilization, sooner or later pioneering humans must forsake a return to Earth and begin to raise families, to live and die in space. As obvious as that seems, many of us cling to pathways of realization that are most unlikely to allow such a natural development.

There are pro-space people and there are pro-space people. The conservative peer-conscious shadow-fearing space-proponents who abound in high places see space as an arena for technology demonstration and ascendancy, for national prestige, and yes, for exploration, robotic and even human. They do not see it as a place for out-settlement, for a cradlebreak from Earth. That's something left to Trekkie fandom and other wild-eyed crazies like ourselves.

As long as our frontier-blazing activities are guided by the official wisdom of politicians concerned first and foremost with covering their butts with their similarly fretful and risk-shy constituents, it's hard to see how such a decision to go ahead with a pregnancy and birth on the Moon could every be sanctioned. Those who are not personally accepting the risk cannot be

expected to have anything but a distorted perspective. And so there will be calls for many years of animal experiments, to see how they survive, mature, and breed, and if their offspring are fertile – above all to see how well Moon-born animals survive the return to Earth. But getting our feet wet, experimenting with real humans by allowing them to do what comes naturally – heavens forbid! [No! Heavens demand!]

It is the pioneers themselves who must accept the risks, and who can be expected to welcome them fearlessly. “Plymouth” is realistic in that official sanctions and taboos will sooner or later be ignored or foiled, and secretly or not, the first human child will be conceived and born in a lunar outpost with everyone a part of the conspiracy to keep it secret until it is too late to foil. Sometimes it is necessary to force an issue with a fait accompli. Politicians like mules, beg to be hit between the eyes with a 2x4.

The problem is, as “Plymouth” brings out so well, getting over the hurdle of trepidation and endless what-if worryings to cross the threshold of commitment to settlement – not outpost or garrison – settlement. In the rebellious tradition of the Heinlein who wrote “The Moon is a Harsh Mistress” and the erst-while Bova who wrote “Millennium”, there must come a time when the pioneers seize their own destiny, and accepting all risks, knowingly plunge ahead, consciously burning their bridges behind them. While the first child-birth off Earth will be a real milestone, the underlying assent to destiny by the pioneer community will be The Milestone with a capital M. This is a step no colonizing Earth government is likely to advocate or bless. Indeed aversion to such a development may be treated as a litmus test of political correctness on the part of would-be pioneer candidates, in government efforts to avert such a turn of events.

As to animal tests, experiments with small creatures with relatively fast life cycles, using artificial fractional gravity in orbital facilities, should give us an early indication of any potentially show-stopping disorders of physiological development under Moon-like conditions. These are unlikely, to say the least.

But in last analysis, we can't know for sure if the Moon is “safe for children” until we bear them there, watch them grow up and mature and have their own children, and see how well the second native-born generation does. For some undesirable traits might not show up until then. Some 20 to 40 years into the commitment to settle, the verdict will be in. For most of us, it is simply a matter of choosing to believe the most favorable outcome. The pioneers who choose to go and gamble with the rest of their lives and those of their yet unborn children, will be of like mind. There is no short-cut from here to there. “There is only do”.

But why should this daunt anyone? After all, we are all involved, every last one of us, in a similar high stakes gamble that we can continue to exist as a technology using species in long-term harmony and equilibrium with our host planet – something we can't know for sure without the risks of trying.

Will native-born Lunans grow tall and lithe? I don't know. Americans of our day are much taller than our ancestors, but because of a change in diet rather than gravity. Will Lunan children and the adults they become be muscleless featherweights? This is unlikely. For mass and momentum remain the same. The likelier outcome is that musculature will be different, not less.

What about their cardiovascular circulatory systems. It will take less heart to pump blood from legs to head, but the same amount of heart muscle to power exertion in work and sports. So there might be a problem with the inactive child and sedentary adult, but not likely with those whose physical life is full.

Lunan sports will likely be new creations rather than caricatures in sixthweight of sports familiar to the Earthbound. Such sports will play to the peculiarly lunar mix of one-sixth gravity and traction versus full normal momentum. Isometric exercises will be more important than weight-lifting ones. Will the attempt, by those wanting to leave Earth return options open, to retain hexapotent (Earth-normal) muscle tone result in grotesquely exaggerated physiques, at least by the new Lunan aesthetic standards?

Certainly the image of the ideal male and female physiques will shift dramatically as the new native born generation comes of age and becomes numerically larger than the immigrant population. Miss Luna and Mr. Luna will not likely appear on the same stage with Miss Earth and Mr. Earth. The pretentious Miss and Mr. Universe pageants may disappear.

Lunan standards of grace will show themselves in new dance forms, popular, ballroom, and pseudo-classical and modern ballet. You'll be able to look at someone and know at once if -he is a native-born Lunan, but that -he is human, there'll be no doubt.

After the first few years of settlement-with-children on the Moon, there will be an interesting suspense about puberty and adolescence, but hardly any surprises. The first real drama will be the rate of healthy births to native-born Lunans. How many miscarriages will there be? How many complications in childbirth itself? How many malformed infants? How many retarded? These are all risks that will have to be faced and willingly accepted.

There are those who feel that after eons of evolution to the tune of Earth-normal gravity, Earth-life cannot adapt. But the whole history of evolution is one great saga of adaptability after another. That we have not adapted to another gravity level is simply because the challenge of doing so has not faced us. Our prediction is that it will be no problem. The worrywarts can stay on their 1G space colonies.

But gravity is not the only thing about which there might be legitimate concern. The mix of trace elements in lunar regolith and the agricultural soils derived from them will be subtly different. There may be deficiency diseases preventable by mandatory intake of dietary supplements and vitamins manufactured on Earth. There may be some level of chromium-toxicity, varying in seriousness from locale to locale. Careful choice of a settlement site considering agricultural needs should prevent severe incidences. Will there be any late-blooming consequences? Probably nothing outside the wide range of dietary variation on Earth.

Again, we must resist the temptation to cater to the perpetually fretful, to those unwilling to cross the mental threshold from the idea of human presence in space to the idea of true human out-settlement beyond Cradle Earth.. Have children we must. And if unlikely medical or genetic disaster does occur? We will have tried. That will be our badge of honor.

[**Editor's Comment 2005:** In the end, the courageous decision to go ahead with pregnancy, childbirth, and the raising of families will be done only in settlements that are founded outside the sponsorship of governments, especially "democratic" governments who must answer to risk-averse public opinion. One of the unintended consequences of democracy is the eventual rise of gutlessness, the tail wagging the dog.]

MMM #52

Xititech



Series Continued [Pronounced KSIH-tees' not EX-i-tees]

Beyond-the-cradle off-Earth settlements ("Xities") will be fundamentally different from the familiar Biosphere-"I"-coddled "cities" that have arisen over the ages to thrive within the given generous maternal biosphere that we have largely taken for granted. Elsewhere within our solar system, each **xity** must provide, nourish, and maintain a biosphere of its own. Together with their mutual physical isolation by surrounding vacuum or unbreathable planetary

atmospheres, this central fact has radical ramifications that must immediately transform space frontier **xities** into something cities never were.

In this issue, we investigate a gamut of essential **xity** functions, some familiar but strongly redefined, others new and without precedent, and their demands upon the structure of **xity** bureaucracies, government, and politics. XXXXX

Xititech

By Peter Kokh

While heretofore in human history many departments of cities and towns (health, light and power, streets, traffic, parks, schools etc.) have at least some number of professionals with germane expertise on their payroll, the policy distorting interference of elected politicians, patronage appointees, and job-secure civil servants more often than not has the upper hand. No matter how poorly citizen needs are met, no matter how “unlivable” in relative terms urban areas may become, people survive. Gaia, the Earth’s mothering biosphere, even in the extremes of its climatic crescendos and geological catharses, is relatively friendly even to the shelterless.

Whatever may be the case some distant day out among the stars, anywhere else in our Solar System hinterland that we might eventually establish pockets of civilization, the hostile host environment will not be so forgiving of task-bungling in the name of self-serving interests. Unlike cities, “xities” must be run largely by professionals and technicians if they are to remain “livable” in a sense that is starkly absolute.

To illustrate, consider the department structure likely to be found in any xity government. But lets go backwards in order of significance to our thesis, that is in order of most familiarity to present day terrestrial urban area experience.

Xity SCHOOL Systems

In this country at least, we have an enormous tolerance for mediocrity and outright failure in our schools. After all, our society (as distinguished from the Japanese, for example) is one of atomic individuals whom we deem responsible for their own success or failure. “God helps those who help themselves” etc. We put a low priority on bettering the odds individuals must face. As a result, we are inexorably becoming a second class nation by all per capita (as opposed to gross) standards of measurement. But we will survive.

On the Moon, Mars, out among the asteroids, or in space colonies in free space, clusters of humanity will be so much more challenged by both high thresholds of economic viability and the fragile vulnerability of all but “sink-less” mini-biospheres. They cannot hope to long survive unless they collectively see to it that their xitizenry is appropriately educated on all points on which their continued existence tightly clings. With one on one attention if need be, they must be prepared to accept a much higher level of individual and actively cooperative responsibility for their “commons” [whatever cannot be privately owned like the air, waters, and the environment in general and for which no one therefore seems individually accountable or responsible].

Along with other subjects, each must learn well the facts of mini-biosphere life and the workings of biosphere support systems in enough detail to appropriately affect their individual micro-economic decisions as well as their environment-relevant housekeeping habits both public and domestic. Useful in building appreciation and respect for the xity’s potential failure modes would be a universal service system in which each student would at some time do yeoman stints on the farms, in air and water freshening and biowaste composting utilities, in discard collection and recycling chores, and on pressure-integrity maintenance crews. Because their existence will be far more critically dependent on technology than even our own, they cannot possibly be either good enough xitizens or enlightened voters if the rudiments of

science and technology are treated as electives as is common practice Earthside. [See “the 4th R”, MMM # 34 APR ‘90., MMMC #4]

Such education will be most effective, of course, if appropriate incentives and conveniences to proper action are built into xity systems. We are too used to passing ordinances without thought to making compliance easy and natural, if not second nature. (If you outlaw spitting on the sidewalk, you should provide handy spittoons, etc.) That will have to change if xities are to succeed against the enormous odds. Living downwind and downstream of themselves, xity-dwellers will be especially prone to choking fatally, en masse, on the business-as-normal by-products of daily life.

Baring censorship, a poor solution, space frontier xitizens, settler and native-born alike, will likely be reminded or exposed to the saturation point with television and videos depicting everyday life in Earth cities under conditions so relatively forgiving as to permit general inattention, dismissal, or even contempt for the commons. In frontier xities, schools will have to sweat up an especially steep hill as a result.

Future Lunans, Martians, Belters, or Space Colonists may not be able to order the latest fashion design, kitchen convenience, or electronic gizmo from the Sears catalog, or go to their neighborhood K-Mart or area mall lined with specialty shops featuring everything under the sun. They may not have supermarkets with an infinite selection of prepared convenience foods, toy outlets featuring plastic incarnations of the latest cartoon heroes, bad guys, and monsters. Nor will the current fare in chic throwaway fascinations Earthside be available.

Instead young and old alike will have to be prepared for the crude, make-do substitutions of the frontier. This will strongly motivate settler artists, crafts folk, and entrepreneurs to make and produce improved and refined goods that from production to ultimate disposal respect their fragile mini-bio-spheres and the recycling systems that help make them work. At the same time such new wares will help build a do-or-die long-term trade surplus (see below) by ever working to further defray “upports” from Earth and expand total exports.

One can imagine the curator of the local museum selecting for the “Reminiscences of Earth” hall, principally ethnic folk and frontier items that, even if not appropriate for space frontier situations, demonstrate encouragingly the best in human resourcefulness under challenge. By contrast, the latest carefree titillations for individual convenience will be well enough represented by film and video.

Xity HEALTH Department

Space frontier Health Departments will be charged with more aggressive attention to public and domestic house-keeping conditions that could promote the spread of any pests that slip through space transportation safeguards (food cargoes pressurized in 150° F nitrogen, or exposed to vacuum; settler screening and clothing trade-ins etc.) But here again, education will be primary.

Public **health dollars** in the U.S. grease the squeaky wheel. Thus much more attention is given to keeping the no-longer productive person alive, than in ensuring that the young do not grow up so unhealthy as to later burden the system. Space frontier settlements will be hard pressed to survive unless a much higher fraction of their populations are productive than seems acceptable on Earth. So priorities will be turned around with emphasis on expectant mothers, infants, children, and seniors with good years left in them. In respect to the latter, the emphasis must be on improving quality of life, not on extending it for extension’s sake. Bear in mind that in very isolated space frontier settlements, xities may be really xity-states, concerning themselves locally with cares here left to the state or jockeying candidates for national office.

Development of all-new Sports will be a new concern for xities, or for associations of xities sharing similar gravity/inertial situations. For most of the traditional sports we now enjoy will transplant poorly. [Jai Alai is one possible exception]. But Earth-return physical and physiological rehabilitation programs might well be left to free enterprise.

Department of SOCIAL Services

For reasons already cited, when it comes to Social Welfare, the xity's "first line of defense" must be before-the-fact prevention rather than after-the-fact assistance or outright neglect (not only in third world cities, but of our own urban address-less). The universal if never stated presumption on Earth that, if need be, people can survive fending and foraging for themselves, will be an all too obviously unthinkable one within the confines of mini-biospheres quarantined from one another not only by miles, but by hard vacuum and radiation or unbreathable planetary atmospheres. Again the stress will be on education and training to be flexibly productive.

Department of ECONOMIC Diversity and Trade

Nowadays, increasingly strapped American cities are taking a much less laissez-faire attitude towards their industrial and commercial bases. For xities, this will not only be a way of countering economic decline as they age, or to promote new and refound prosperity, but a matter of sheer survival. In point of fact for Earthbound cities, as the nations they drive, a negative trade balance with the outside can be sustained for a surprisingly long time – though tolerated slippage in the standard of living, and/or reversion to "simpler times" – read more direct reliance on the support capacity of "Mother Earth". And through income redistribution bandages, areas that lag badly can be propped up by those enjoying better times.

Neither recourse is likely beyond Earth-orbit. Xities will either ever re-justify themselves economically, or they will end up being abandoned, sooner rather than later. Xities, and associations of xities sharing the same planetary or space setting, must through publicly supported means, endeavor to ensure that local entrepreneurs find ever new ways to turn local resources (or other raw materials more cheaply accessed than shipment up the expensively deep gravity well from Earth) into new products for domestic consumption to reduce the need or pressure to upport from Earth, or into products for sale to Earth, Earth-orbit facilities, and to other off-planet settlements, in sufficient volume to fully pay for whatever upports and other imports that the xity cannot (or prefers not) to do without – and to do so with reserve-building surplus.

A **xity university**, however modest by today's standards, would be a logical agency to promote industrial and commercial diversification, even helpful new arts and crafts. The university could do ground-breaking materials use research and then assist entrepreneurs in development of marketable products for some limited share in the royalties.

To support this diversification, xities on planetary surfaces (Moon, Mars, larger asteroids, etc.) will support continuing development of the potential economic geography of their hinterland surroundings. This will mean establishing satellite outposts (some of them perhaps to become rivaling xities in their own right) in order to add to the mix of minerals and raw materials upon which economic diversity rests.

Space Colonies, each more like Singapore than analogs of giant Japan (a comparison frequently made), may bind together in leagues to better exploit asteroidal and cometary resources. The goal will be to lessen the restriction of their economies to industries supportable by a diet of lunar raw materials alone. This need to establish and continue a favorable trade balance will drive an initial handful of surface and space xities ultimately to develop much of the Solar System, whether Earth itself remains interested or not.

An **Office of Strategic Materials and Import Protocols** could employ some blend of taxation and credits to ensure that strategic materials in short supply (e.g. on the Moon: hydrogen, carbon, nitrogen, and metals other than iron, aluminum, titanium, and magnesium) were not diverted into spurious luxury uses or tied up in non-durable products without efficient fast-turnaround recycling systems that work.

It will be also be in the xity's interest to maximize **interxity trade** so that together the xities are not just finan-cially self-supporting but also industrially and agriculturally self-sufficient if ever Earth cuts off trade, whether as a result of world conflict, major depression, isolationist politics, or the spreading of hostile fundamentalisms in the various world faiths.

Such an ability to collectively survive the cutting of the umbilical cord to the womb-world must be the cornerstone of every xity-state's "foreign" policy.

Department of the Xity BIOSPHERE

The differences between mega-biosphere-contained cities and mini-biosphere-containing xities, as described above, while significant, may seem matters of stress, emphasis, and priority. We won't argue the point. But that's as far as one can stretch the kinship. No city on Earth must build a containment system, mega-structural of modular, for its atmosphere. Nor need any city on Earth concern itself with maintaining its own climate or the routine sequencing of its seasons (beyond the provision of air-conditioned skywalks and other structure-connecting passages, as popular perks).

No city on Earth must be dependent upon a closed loop water supply, drainage, and recycling system totally within its own limits (even island city-states like Singapore have the surrounding sea). In contrast, no xity will ever be founded on a coast or lakeshore or river or over a subsurface aquifer – at least not until the "rejuvenaissance" [a coinage decidedly preferable in its connotations and the pathways it suggests to "terraforming"] of Mars is fairly well along.

A Corps of Pressurization Engineers will be charged with containment integrity and maintenance of the atmospheric pressure of the settlement within the desired limits. Ever vigilant for leaks and structural weaknesses, they will preventively repair microcracks, monitor the performance of sealants, and relieve structural stresses safely. Automatic detection devices and frequent human inspections will be crosschecks in preventing failures of regular airlocks, liquid airlocks [MMM # 17 JUL '88], and matchports [MMM # 15 MAY '87 – both included in MMMC2]. The corps' job will be different in megastructures such as O'Neill colonies, Bova-Rawlings' Main Plaza [Welcome to Moonbase, Ben Bova, Ballantine '88] or the double vaulted rille-bottom villages of the Prinzton design (LRS '89) from that of those charged with this most critical of all xity responsibilities in modularly constructed settlements with physical growth potential (banded and modular torus space colonies, the double helix oases [MMM # 11 FEB '88], and any of the more common Moon and Mars base proposals. Depending on the settlement's overall architectural plan, separated or separable fall-back safe havens need to be provided and maintained.

The work of the corps presupposed, the **Office of Atmosphere Quality** will be charged with maintaining air freshness and the proper mix of gasses: oxygen, nitrogen or other buffer gasses, and carbon dioxide.

The settlement may have some sort of baffling separating the agricultural, residential, and industrial areas. If so, the fans and ducts which provide for flow of fresh and stale air across these baffles without back flow, need to be maintained to preserve air quality.

The **Hydrosphere Office** will maintain the xity's water reserves and their cycling starting with the dehumidifiers that condense excess humidity from plant transpiration to provide fresh clean drinking water. The Office may maintain a tritreme drainage system [MMM # 40 NOV '90 "Cloacal vs. Tritreme Plumbing"] that keeps separate, for ease of treatment, sanitary waste water, gray water from washing and bathing, agricultural runoff, etc.

On the Moon, reserve water supplies may be shunted in a cycle through dayspan electrolyzers and nightspan fuel cells to produce power to complement off-line solar generators. Reserve water can even be cycled through closed-loop high head rille-side or crater-side hydroelectric stations, again to boost nightspan power [see MMM # 31 DEC '90 pp 4-5; also in MMMC #4].

But reserves can also be used to improve air quality by running them through fountains and waterfalls to mist and cleanse the air, and to add further to the quality of xity life in the form of canals and lagoons for boating, pools for swim-ming, and even trout steams for fishing.

Whereas some cities take upon themselves the task of providing and maintaining green markets by which produce from rural farms can be sold directly to city dwellers, in xities

beyond Earth, under the Biosphere Dept., there will be a **Sub Department of Agriculture**, with far more responsibility than even national agriculture departments here on Earth. For in xities, the antithesis of farm and city will be resolved. The xity will contain major agricultural areas within its biosphere, not only for logistic and economic sense, but because the farm areas will play the critical role in the recycling of stale air into fresh. The composting of solid organic wastes will be its duty.

A system of parks, pathways, picnic strips and memorial gardens might well be integrated into portions of the agricultural areas adjacent to residential, industrial, and commercial zones. Since the emphasis will be on plants that serve an economic need, even landscaping and “streetside” plantings will be selected to fulfill a dual purpose. Thus the whole eco-system makeup of the xity biosphere’s general flora will be under this sub-department.

Agriculture will also bear upon the selection of livestock (if meat-eating survives as an accepted lifestyle) and the xity’s complement of urban “wildlife” (some species needed to make the ecosystem work, and maybe some others more for public enjoyment). This sub-department would also license allowable pets and enforce their reproductive control.

As serious a job as is running a major city in today’s world, the burden of responsibility on the Xity Parents out on the space frontier will be much heavier. The very continued existence of the xitizenry will lie in their hands. There will be far less room for the discretionary nonsenses of political decisions, far more entrusted to the care of responsible technicians. This will affect not only the structure and divisions of xity bureaucracy but the roles of elected officials and how they see them.

These life-in-the-balance responsibilities may even require final abandonment of the dictatorship of the majority [our present system, wherein each faction attempts to gain a mere 50% plus advantage, in order to thrust some premature solution serving vested interests down the throat of any other equally noncooperative faction] for governance by informed consensus. Government by co- “promise” not by compromise.

The extraterrestrial xity will be a precedent shattering institution. And just maybe, Earth cities will pick up a few helpful pointers in the watching. FRMMPL

MMM #102

The Grand Archives of Earth and Humanity

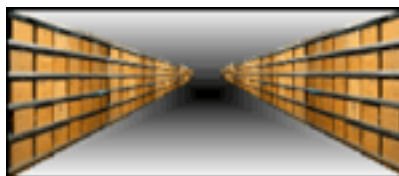
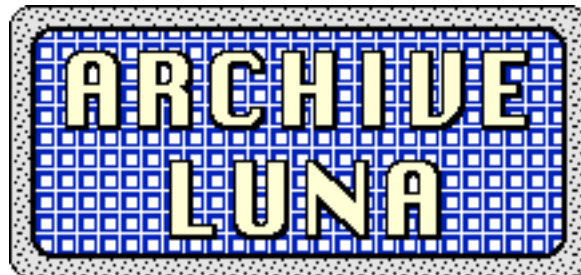

The sterile, airless Moon is already a depository of much cosmic information. Within some lavatube secure from cosmic weather, humans can take a cue and create

The Grand Archives of Earth and Humanity

By Peter Kokh

Four billion years of geological archiving

Archiving, specifically and specially of the asteroidal and cometary debris bombardment of the lunar surface, and well as of the aeons of solar wind particle buffeting, have built into the magnificent desolation of the global moonscapes an eons-thick scientific archive of inestimable value. As such, the Moon has served, and still serves, as a natural probe of the near solar environment that our human-made robotic probes can only hope to dimly emulate.

The conditions on the fully exposed lunar surface, even more so within the partial shelter of permashade, and best in the yet-to-be-sampled full-sheltered environments within subsurface lunar lava tubes are such that deliberate archiving by humans of both cultural artifacts and vulnerable biological samples and specimens, are a suggested-in-heaven industry of considerable economic value for future Lunan settlements. Archiving will be one Lunan activity with all the marks of a 'vocation' or 'calling'.

Archiving on Earth is, and has always been, an activity fraught with danger, peril, and inevitable disaster. Remember the Library of Alexandria, and the art treasures of Florence lost in the flooding of the Arno, treasures and records destroyed in war, by earthquakes, mud slides, fires, and hurricanes, sadly, even by vandalism. The safest and most secure and environmentally stable environments on Earth can guarantee preservation of objects, artifacts, and records for relatively short times. Sooner or later, all human treasures preserved on Earth will be lost to the forces of human activity, weather, biological activity, and geological forces within Earth itself.

The sight lines of most of us are short. We pretend to worry about a slate-wiping asteroid that may hit us any time over the next few millions of years. Yet no Canadian or Scandinavian loses a night's sleep over the certain revisit of the great ice sheets within the much shorter time frame of the next ten thousand years or so. Most of us care about what carries over to the next generation. After that — we're content to let the next generation worry about it. That is why the inexorable deterioration of the biosphere and of Earth's living ecosystems does not bother most of us. It is sufficiently slow relative to our own personal four score years of life expectancy. *Après moi, la deluge!* ("After me, the deluge.")

But there have always been those with a more eternal vision, from the scribes of ancient times to the Pharaohs to the medieval monks. The upshot is that much of human history has in fact been carefully preserved despite common indifference. Yet in the long run, what we add by archeological, philological, and historical research only adds to the amount of knowledge that will inevitably be irretrievably lost.

The first task facing would-be curators of the *Musea Humana*, is to find a depository site large enough and secure enough to preserve accumulated human intellectual, industrial, cultural, artistic, and similar wealth not just for a few generations, or even some centuries or millennia, but for veritable eons — yes, for billions of years!

Why! Certainly some for religious reasons based upon fundamentalist literary interpretation of this prophetic text or that, will be dogma-certain of the impending "end of the world" and see such an archiving task as complete folly and poppycock.

This essay is for the rest of us, not fortunate enough to be blessed with such private certitudes. For us, the reasons why are several. Transgenerational memory, without the prop of preserved reminders (museums and archives) are very short and quite inaccurate. Handing on knowledge of the present and past is one of the sure values we have to give the generations who follow us (along with a well-husbanded environment over which we exercise only temporary stewardship, a weightier burden than most feel or realize.) We need to preserve the record (as well as to add to it!) in a way that will keep it safe and inspirational and educational for generations to come. We have to think in "time capsule" mode.

Beyond the edification of far future descendants is the more mystical need felt by even fewer of us to preserve the human, and Gaian, record even beyond the possible death of humanity and Earth life as a whole. For whom? For others, maybe never, maybe just once or twice — we cannot know or estimate — of other origins, who happen by this way in their sojourning through whatever interstellar neighborhood the ruins of Old Earth find themselves at

the time. It is a need, a sacred call, to give witness. For what we have achieved and done, at least the modicum of positive within the pile, will give eloquent testimony whatever Creative Agency(ies).that led to and fed our rise as an intelligent species.

The only place to do such archiving for the eternities is on the Moon, in (an) intact lava tube(s) that has(have) already survived inviolate for going on four billions of years — not millions, billions! Any passerby surveying our solar system,.in whatever shape it may be in at the time, however distant in the future that visit may occur, cannot but come to the same conclusion. In all this System, lunar lavatubes are the most secure possible repository. (This is, of course prior to the Sun’s eventual aging and pre–death expansion into an inner planet melting red giant star before contracting into a white dwarf cinder some billions of years down the road.).

If you follow this line of reasoning, it should become clear that any visitors who have come our way in the distant prehuman past will have seen lunar lavatubes as the only site worth considering if they chose to leave behind some testimony of their passing (whether it be information about themselves or the more Cheshire Cat–like smile of leaving us a record of the Earth and its biosphere of that time, something of a depth and completeness and richness that we could never hope to reconstruct on our own. Thus Incomprehensibly enriching witness of a visit can be left without prejudice to the “Prime Directive” which may enjoy widespread if not cosmos–wide respect.

When we think of archives, we think of such inevitably trivial data such as genealogical records, and perhaps a more worthwhile mix of artistic and literary treasures encompassing the mediocre and degraded as well as the sublimely inspired. Government, institutional, bureaucratic and other historical records will be in the trove, to be sure – leaving to the future to find whatever is of value to those mining the hoard. Exhaustive samples of industrial creativity and scientific achievement must be included if the whole sample is to have unskewed worth.

Biological records will be a principal part of the whole. Intact preserved samples of every extant species will be priceless in a future in which many species will have become extinct. A geological picture of the ever–changing Earth and an astronomical survey of the solar neighborhood out to galactic depths will help future visitors pin down the epoch in which the archives were created, and the length of time during which they were maintained.

Archive science will spur much inventiveness as archivers strive to find and use ever better methods of preservation, display, and cataloging. As such, archiving will become a driver of progress of considerable value, creating for Lunans considerable intellectual property value.

At present, all industrial, historical, and art collections and records on Earth are at risk. In many cubic miles of available lunar lavatubes, immune to cosmic and geological events, with constant temperature, absolutely dry vacuum, total darkness and minimal background radiation, we will find our single best bet to keep safe for others the record of what we have collectively achieved, as well as of what nature has left us to steward. Low–maintenance very long life presence/motion–activated solar electric lighting along archive aisles can be installed for use during surface dayspan. ##

MMM #109

Luna City Streets

[Only those article sections that show a maturity that merits home rule are reprinted below.]

Luna City Streets

By Peter Kokh

Foreword

[NOTE: In MMM #52 FEB '92 p. 2 "Xities" we introduced **the term "Xity"** (to be pronounced **KSIH ty**, not EX ity). "Beyond-the-cradle off-Earth settlements ("Xities") will be fundamentally different from the familiar Biosphere-"I"-coddled "cities" that have arisen over the ages to thrive within the given generous maternal biosphere that we have largely taken for granted. Elsewhere within our solar system, each xity must provide, nourish, and maintain a biosphere of its own . Together with their mutual physical isolation by surrounding vacuum or unbreathable planetary atmospheres, this central fact has radical ramifications that must immediately transform space frontier xities into something cities never were."]

The "Streets" of Luna City

We might define a street as an engineered passageway that connects buildings and other places where people, live, work, shop, play, and otherwise congregate. The earliest improvements in the construction of village and urban streets include paving and guttering.

[snip]

In more modern times, we have seen the emergence of climate controlled pedestrian malls everywhere where heat, cold, rain or snow might interfere with profit-generating shopping activities. And we've seen as well the downtown sky-walks and underground galleries facilitating the busy bustle of vibrant snow belt downtowns, for example, those of Montreal and Minneapolis. Yet, despite such developments, it is still far more common for pedestrian and vehicular traffic to share rights of way.

[snip]

On streets of mixed use, the tendency has always been to maximize the amount of activity they enable. They are landscaped for maximum ambiance and attractiveness, and lined with shops, eateries, service establishments and other amenities meant to encourage pedestrian and vehicle stop-ins.

What might the streets of a future Luna City be like in the early era before the emergence of atmosphere-holding "mega-structures" such as crater domes, rille vaults and sealed lava tube courses?

On the Moon we have inarguably extreme climate at all times: radiation-washed, micrometeorite-splashed hard vacuum with extreme though superficial temperature swings. A more benign "lee vacuum" is available at the price of a ramada* or canopy over the trafficway. But for urban in-town purposes, all purpose pressurized climate-controlled shirt sleeve accessible pedestrian and traffic tubes will be as vital as the pressurized, climate-controlled shirt sleeve accessible habitats, labs, factories, shops, offices, etc. that they link in one inter-continuous mini-biospheric maze. In the course of everyday life, the urbane Lunan will don a spacesuit only during infrequent but seriously conducted "decompression drills". Even travel "abroad" to other settlements or outposts will be by hard-cocked vehicles, our airport jetways offering a very primitive foretaste.

* [MMM # 37 JUL 90, p. 3 "Ramadas"]

Size and Scale

The humble ancestor of the lunar settlement street will be the outpost hallway as it first becomes suddenly transformed by the merchandising of dawn era made-on-Luna artifacts (wares, wears, or both). As the outpost is superseded or absorbed into a conscious settlement effort fueled by the availability of locally processed building materials and architectural components, such cramped passageways will be followed by much more spacious corridors handling both people and vehicles.

If we must build these long interconnecting cylinders to carry the everyday commercial and social intercourse of the lunar city, then surely it makes sense to build them on a generous scale, with ample radius to allow not only pedestrian and vehicular traffic, but serious agriculturally productive landscaping. This more directly interconnected city gridway-plex

would then contain the lion's share of the city's shared biosphere and of its biomass-run climatic and regeneration flywheel.

[MMM # 51 DEC 91, p.p. 3-4 "Everfresh"]

[MMM # 57 JUL 92, p. 6 "Space Xity Biomass Ratios"]

[MMM # 64 APR 93, p. 9 "Towards Biosphere Mark III"]

[MMM # 96 JUN 96, p. 5 "A Green Security Blanket"]

[snip]

Once more generously radiuses cylinder sections can be built, these may be reserved for neighborhood-connecting cross-town arterials, and for commercial, industrial, and agricultural frontage roads. The narrower variety may continue to be produced for use as quieter, cozier traffic-restricted residential lanes. On the other hand, large enough cylinders could contain housing on their side terraces rather than just provide access to separately built modular housing, as illustrated below:

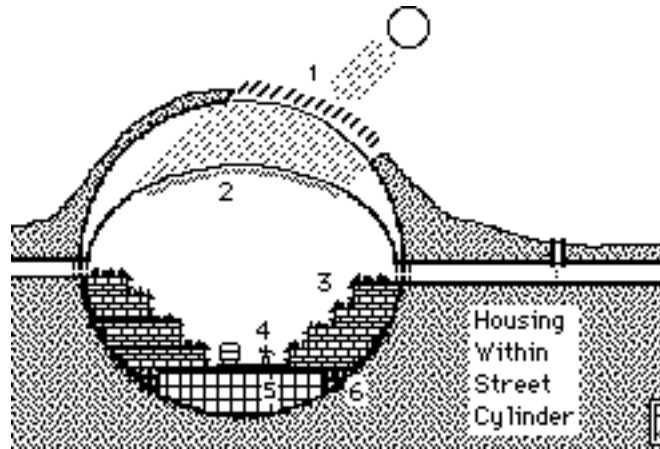

THE RESIDENTIAL STREET ('HOOD) AS THE MODULE

Cross-Section of cylindrical street module 40m x 700 m: [1] shield louvers that let in the sunlight; [2] a suspended sky-blue diffusing "sky" - air pressure would be the same on both sides; [3] terraced residential housing with rooftop gardens; [4] the thoroughfare running the length of the (neighbor)'hood; [5] light industry and shopping, possibly offices and schools; [6] conduits for utilities.

Whatever their individual dimensions, the town street grid would present minimally clogging obstructions to an effective air circulation system. This could be set up to flow in neighborhood cellular loops* starting with farms, flowing through residential areas, past commercial areas, through industrial zones and back into the farms in self-cleansing loops similar to the human heart-artery-vein-liver-lung loop. In contrast the aggregate of individual and conjoined homes, town homes, and apartments, of shops, offices, factories, schools etc. that we more commonly think of as "the city" will in large measure be interconnected only indirectly, via the streetplex.

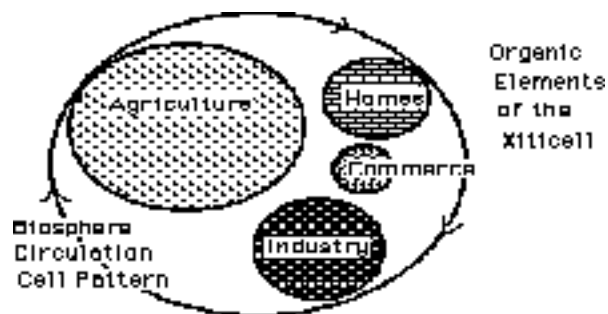

BASIC ELEMENTS OF THE XITY FOUND IN XITICELLS

A generous radius would allow pedestrian and mezzanines lined with alcove shops and cafés, tiered above general trafficways and transitways, still allowing relatively uninterrupted green space on the floor and terraces. To make that work, relatively continuous solar access strips will be built-in features of the ceiling, if not replaced by artificial but more efficient grow-lighting. Nightspan lighting can make use of the solar access system (the actual lamps, and their heat, situated out-vac on the surface) or via artificial task and area spotlighting.

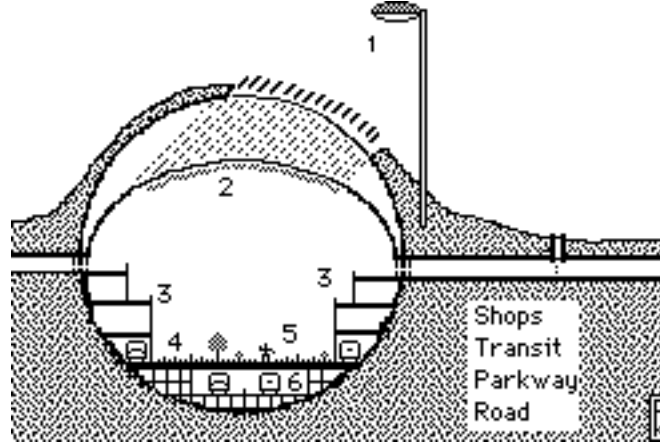

Cross-Section of cylindrical street module 40m x 700 m:

KRY: [1] shield louvers that let in the sunlight during dayspan, artificial light during nightspan; [2] a suspended sky-blue diffusing "sky"; [3] terraced shopping mall on either side; [4] transit buses; [5] pedestrian parkway strip; [6] 'underground' road, utility conduits.
[snip]

The complete organic function of the street demands it carry the major utility runs: electric power with intervalled junctions, communications cables, fresh air ventilation booster fans and ducts, heavy and light stale air "gutter ducts", fresh water supply and used water drains, the latter carefully segregated by source (e.g. toilet, bath and shower gray water, kitchen sink-garden-farm-landscape runoff)

[MMM # 40 NOV 91, p. 4 "Cloacal vs. Tritreme Plumbing"]

As we've pointed out elsewhere, "somewhat clean" reserve water on route to further processing could be channeled through the agricultural or landscape terraces via open canals and/or trout-streams and thus do double duty, creating ambiance, allowing canoeing and row-boating, fish-watching, even trout-fishing. Here and there sidewater lagoons can serve as swimming ponds and water lily gardens, even a lagoon for a city mascot pair of flamingos. Here and there, cascades and locks and waterfalls and arched pedestrian bridges can be worked into the scheme. Periodic dehumidifiers (humidity, not dryness, is expected to be the bane of man-made biospheres) can feed waterfalls and drinking fountains, draining into the fresh water supply lines.

[MMM # 67 JUL 93, p. 6 "Reservoirs"]

The "Middoors"

The beachhead science outpost will be simply a pressurized indoors up against the outlocks vacuum, the out-vac. Whenever it makes its appearance, in such a government outpost or in an early company mining town, the construction of the first spacious atrium solarium garden will introduce a new kind of space - a space external to individual quarters, lab modules, and other work- and function-dedicated pressurized places, yet still keeping out the life-quenching vacuum beyond the airlocks and the docking ports. What we have called the "middoors" will be born.

From this humble beginning, airy, spacious, verdant middoor spaces will grow to the point that they may eventually contain the greater part of the settlement's atmosphere and biomass. And with it, the hoped for "biospheric flywheel" will become much more of a reality.

It is within such spaces that longer, wider sight lines will appear, offering postcard views and vistas, to dull the edge of early day claustrophobia. The settlement will begin to take on the trappings of a little "world", a continuum of varying horizons. The effects on settler morale will be considerable.

"Indoor" spaces will be the more tightly climate controlled, allowed to vary only slightly from comfortable "room temperature" and humidity levels. In contrast, the middoors may be designed to swing freely, say from a late pre-sunset dayspan temperature that is tolerably warm and humid, to a late predawn nightspan temperature just enough above freezing not to harm the various plant-forms within. "Sunthly*" "weather" patterns will add welcome variety and spice to day-in, day-out life.

* {a sunth is the 29.53 Earth day long period consisting of a 14.5day long dayspan (continuous sunlight) and a 14.75 Earth day long "Nightspan" (continuous darkness)

That foremost conversation-making unpredictability of terrestrial weather, however, may be hard to program in. If temperate food plants are desired, perhaps an annual hard frost might be arranged one nightspan a year, as part of a partial cleansing freezing out of mounting atmospheric pollutants and impurities. It's a thought. And depending on ceiling heights of the street vaults, any gradual increase of humidity levels beyond a certain point might trigger mist-making condensations, say sometime after local sunset. At any rate, such middoor "weather changes" will help keep the populace healthfully invigorated, as well as supplied something innocuous to complain about. A fringe benefit will be the generation of a whole new cottage industry to create fashionable "outerwear".

[MMM # 5 MAY '87, "M is for Middoors"]

[# 94 APR '96, p. 4 "Vac, Out-Vac, Lee Space, & Middoors"]

[MMM # 96 JUN '96, p. 6 "Space Suit Aversion"]

Intersection "Node" Modules

INTERSECTION NODES: Try to imagine the International Space Station without its module/docking port connectors. A lot like a Tinkertoy set without its connectors – won't work! The so-called nodes may be the lesser part of a complex architectural construct, by volume, but they are what holds everything together.

A street grid without intersections would be limited to a monolinear layout with street cylinder modules laid end to end. This is not an unworkable system, and I can think of at least a couple of U.S. towns that are pretty much laid out along one loonng street (Niagara WI, Bisbee AZ etc. and many more that do have cross streets but are overall strongly linear, compressed between hills and shoreline, along riverbanks, in narrow valleys, etc.). But a linear network, however well it might work for computers (or not), is not a good way to encourage maximum networking and economic and social interaction between humans.

COMPLEX STRUCTURE: In comparison to the street cylinder modules, intersection nodes have to perform functions which make them complex architectural and design challenges.

Utility System interconnects: if utilities (electric, fresh water, waste water, communications) are carried in service chases in the lower part of the street cylinder (beneath park and road surfaces, etc.) then somewhere in the intersection node module, their must be tributary / distributary connections and access provided to service and maintain them.

Traffic Lane and Walk Exchanges: this can be kept simple, as in yield/stop sign/traffic signal controlled common grade crossings that are the norm in most terrestrial cities. Or an infrastructure choice can be made early on to provide full or partial grade separation "interchanges", separation not only of crossing vehicular traffic, but of pedestrian from vehicular traffic. These are architectural and engineering challenges only, constrained, however,

by available money on the one hand, and by radius and scale (allowable elbow room) on the other.

Next to the common grade crossing, the traffic circle is the simplest interchange solution, an option used with some success in many cities. A more generous floor plan radius with a high dome over a landscaped pocket park within the traffic circle, with grade separated pedestrian bridges is an example of what could be done.

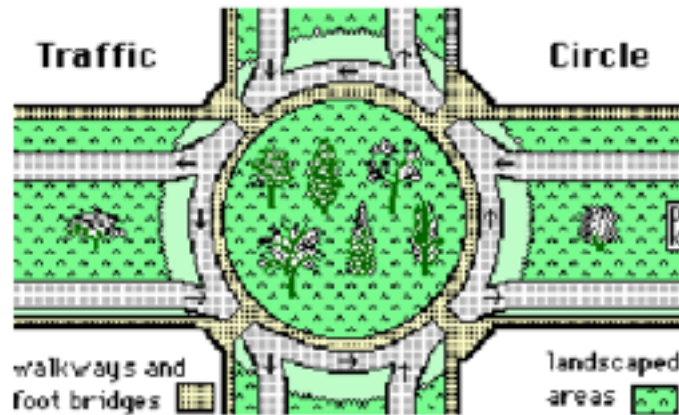

A tri-level grade separation (2 free through-flow separated levels, a 3rd signal controlled turn level, alternately allowing two sets of turns as below) would be desirable where traffic volume is greater.

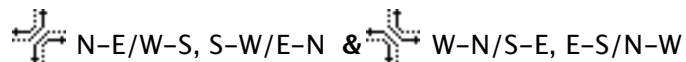

Pressurization Sphincters: by all estimates of lunar meteorite bombardment frequencies, (if you put an Earth-type city of 500,000 on the Moon's surface, you could expect one home per year to be "taken out" by depressurization from a meteorite strike, a loss rate far, far lower than most cities experience from fire) major depressurization strikes involving a direct hit on a street cylinder or intersection node should be very rare indeed, less than one a century in a smaller settlement. All the same, we could not afford one such strike to depressurize the entire "middoors" grid, and with it, the bulk of the settlement's biosphere. The only way to prevent this however is by emplacement of closable pressure doors or sphincters at intervals throughout the grid. Now these could be part of the intersection nodes, at the point where they connect with the (four) street cylinders, or they could be part of the street tubes themselves at each end, or, more economically, along the midpoint of each (halving the total number to be built and maintained). These are architectural and engineering questions. And quite a design challenge too, if it must be ready to deploy at anytime, even if unused for decades.

Perhaps there could be alternative systems in place to deal with minor "hull" breaches and leaks where air loss and air escape velocities are low. Any such system would be triggered either mechanically (power off fail-safe) or electronically by devices that sensed sudden pressure drop, or sudden increases in normal ventilating air current velocities. The salient estimate is of time needed to clear the area at risk.

Sound Baffling: If we don't want the settlement and its middoors street plex to be intolerably demoralizing over the long haul, architects and engineers will have to give full attention to sound baffling – something that is of much less concern in our terrestrial open-sky cities. The needed materials and construction methods should pose no problem. Whether bound-baffling features should be built into intersection nodes is a decision that will be made opportunistically, depending on overall design and other special features. Certainly, vegetation and trees would help.

MODEL VARIATIONS: there will be a number of intersection node modules, depending on the mix combination of intersecting street cylinder sizes and on whether or not extra height is allowed to enable grade separations for smoother traffic flow. One might expect intersections

of four residential street tubes to differ quite a bit from one joining four commercial avenues, or a pair of each.

USAGE DESIGN CHALLENGES: Additional tweaking of designs is in order to meet expected use patterns: hosting town center institutions, offices, commercial shopping, entrepreneurs, cottage industry and arts and crafts markets and fairs, food court and rendezvous plazas, hosting festivals and parades, etc.

Signage, Lighting, and Individual Ambiance can be given architectural roots, and left to user embellishment. No busy settlement intersection need look like any other (e.g. the strikingly different, each stunningly beautiful stations on the Moscow Metro Circle Line).

To serve pedestrian traffic between parallel or neighboring streets in areas where intersecting streets are far apart, "shortcut" pedestrian "cunicular" tubes might be built. These will be small in radius, at best with a shallow side terrace for hanging plants, flowers, bonsai forest strips etc.

[snip]

Public Transit Options

In the same environment, public transit vehicles can also be open-air, starting with simple railing-sided flatbed street rail cars with benches, operating automatically much as modern operator-free elevators. Trackless trolleys are feasible. Battery operated coaches will be more expensive to operate. In the light gravity of the Moon, side-rail suspended cars and vault-suspended monorail cars should be very feasible and popular. Station stops could be just before or just after intersection nodes, or handy to mid-block pedestrian bridges.

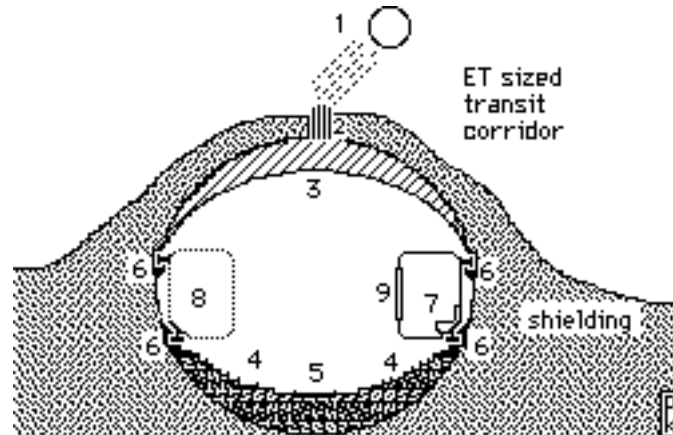

KEY: (1) Sun, (2) fiber optic bundle sun pipe, (3) sky-blue sunlight diffuser (same air pressure either side), (4) terraced plant beds, (5) gardener's path, (6) wall-mounted rail suspension system, (7,8) bench seat transit car, (9) door.

Special Uses

Commercial concentrations can either grow up around favorably designed or well-placed intersections, or alongside individual street cylinders themselves. "Nucleus" intersections can be built at planned intervals, each to develop their own individual mix and ambiance as neighboring enterprises and cottage industries and neighborhood associations make use of them. One such may in time emerge as hub of "the downtown" but that can be left to the free unfolding of city life, and need not necessarily be replanned.

Some streets may be specially designed to handle ethnic, music, and art festivals. Others can be laid out with parades in mind. And some should be intended to serve as park strips for retreat and relaxation and fuller enjoyment of urban greenery, maybe even token urban wildlife [see below].

[snip]

Streets that serve food-production areas (farms) might be encouraged by tax law to provide adjacent small parks and garden spots for the public as well as roadside produce markets. Because there are no natural lunar annual “seasons”, crop harvests can be staggered to occur every sunth (29.5 days). Fresh produce will generally be always available.

[If the settlement in whole or in part adopts a temperate climate with a hard frost sunth, in order to produce temperate zone fruits and vegetables, this would not apply. In this case, there could be two sunth-short frosts and two five sunth growing seasons annually.]

This said, however, in time, to serve growing demand for partially processed foods and the domestic meal preparation time-savings they represent, food processing enterprises may sprout up along these farm frontage roads. They will be supplemented by cottage industry home canners selling their wares in neighborhood markets. The farm road processing outlets will want to make their frontages as attractive as possible to potential customers. To do this they will use a variety of inorganic decoration methods, as well as land-scaping and, of course, product display.

Doing Without “Commons”

The “commons” are areas owned by “no one” — thus subject to neglect, trashing, and cancerous blight — or by “everyone” and thus maintained at taxpayer expense. The difference between the two is nothing more than a budget-mandated choice tipped by the good or bad graces in which adjoining property owners are held at city hall. (who is most effective in greasing the palm). Instead the city should be concerned with utility and recycling systems and biosphere regeneration and maintenance. These city gut systems can be maintained by youth during tours of “universal service” keeping the tax-supported payroll to a supervisory minimum. City adoption of “commons” area creates the temptation to show favor and disfavor (e.g. to the rich and less-affluent respectively).

For areas available for planting and landscaping, both options can and should be avoided. This can be accomplished by individual or corporate ownership of larger plots, and individual and group adoption of maintenance chores in the upkeep of smaller plots. Groups can be of homeowner cooperatives or business / marketplace associations. Garden spaces of spice and salad-stuffs can be run by local grocer/eatery coops. Decorative garden plots can be managed by cottage industry market coops placed within or alongside them.

The model for this is the spreading adopt-a-mile programs one sees more and more along the approaches to cities and towns in this country. Individual and group self-pride and good-natured rivalry combined with design talent and maintenance energies can lead to a very high average state of both adopted plots and the larger privately owned plots within the various street cylinders. Wealth, of course, will “out” and the adopted “commons” of more well-to-do areas will inevitably be, on average, more luxuriant and decorous, than those in lower income areas. Wealth, however, has no native mono-poly on inventiveness, hard work, art, and ingenuity – these are the great levelers.

[snip]

Street Vegetation and Forestry

Purely decorative flowers, plants, shrubs and trees producing neither food nor fiber, herb or spice, dye stuff or pharmaceutical, will be hard to justify. An exception might be a memorial floral gardens partially fertilized with the ashes of departed pioneers. Such a special spot is bound to become a favorite backdrop for wedding photos etc. Some small luxuries are simply worth the cost.

Fortunately, some environmentally conscious landscapers are having great success on Earth making decorative and ornamental use of food-bearing plants and trees. Pioneers may enjoy no oaks or elms, pines birch, or cypress – but there will be orchard trees like apple, pear, cherry, orange, banana and the like, and fiber-producing trees like Kapok. Others have suggested bamboo, useful for making informal furniture, scaffolding, etc.

Personally, while I can see a great role for bamboo on nitrogen and carbon rich Mars, the idea of permanent withdrawals from the costly, volatile-limited lunar biospheres seems an obscene luxury. Perhaps it can be allowed if accompanied by a discouragingly high luxury tax, high enough to pay for the replacement volatiles involved. Along the same line, wood may be so precious on the Moon as to make it a favorite jewelry stuff. Hard cherry and apple would be natural for such uses.

The major determinant, however, will be the design climate of the street-grid biosphere. If semitropical, i.e. never freezing, we'll see a completely different list of food bearing plants than if it is designed to freeze seasonally, in temperate fashion.

Possibly various neighborhoods could be designed diversely in this respect so that the city as a whole enjoys a greater variety. It is the more likely that climate will be a city-wide choice, however, and that some towns will be temperate, others subtropical, others tropical, etc. Variety at the produce market will then come from vigorous inter-town trade. Such differences in town climates will also generate healthy inter-settlement tourism, making possible welcome changes of scenery.

Many fruit and vegetable plants produce blossoms prior to fruiting, and such blossoms can take the place of purely ornamental blooms in adding seasonal dashes of color and beauty. Simple juxtaposition of useful plants of various heights, shapes, and shades of green will be pleasantly decorative enough as a free plus.

As to trees, we will see a definite change in maximum allowable height as the settlements grow and mature. The first "pocket forests" may actually appear in early outposts – caricature groves of "pet" bonsai trees. There will be room for little more.

Next will come dwarf orchard tree varieties which can be planted even in in-home atrium garden solaria. But as street cylinders of ample radius are built, we will have room for much taller fruit and fiber trees, even bamboo grasses.

[MMM # 2 FEB '87, "Moon Garden"]

[MMM # 8 SEP '87 "Parkway"]

[MMM #50 NOV '91, pp. 8-9, "Trees on the Space Frontier"]

Urban Street Wildlife

A biosphere without wildlife might be more efficient. But it would fail utterly to teach and remind young settlers of the host planet, teeming with wildlife, into whose midst the human species emerged. It will be both more educational and more morale-boostingly healthy to have some wildlife, however sparse and token.

The worthiest niche will be for pollinators. On Earth, these include honey bees, hummingbirds, some butterflies, and some bats. Their presence will give delight to many, as well as teach how real ecosystems work. Where plantings are in soil rendered from carefully aged regolith with the assistance of microorganisms, earthworms will introduce yet another phylum, yet another example of life's tremendous capacity for diversity.

A small captive flock of slow-breeding flamingos might quickly establish itself as the popular town mascots without devouring too much recyclable biomass. Certainly such animal mascots would cost the settlement orders of magnitude less than would any human mascots of some monarchy!

If there are open water canals making use of reserve water in process of treatment for recreational use, these can be stocked with both game and decorative fish (e.g. trout and poi). A large aquarium would serve even better to teach and remind youngsters how life began, in the oceans. We hope to speculate more on such options in another article.

[MMM # 8 SEP '87, "Animal Life"]

The Street Plays Host to City Life

The first settlement streetscapes will be pretty drab. Few decor and landscape options; little variety in apparel; a paltry selection of consumer goods, mostly of crude "experimental"

quality. As settlement industry diversifies in search of an ever longer list of export goods, new materials for building and crafting and artwork will appear, new finishes, new colorants, new tools, new methods. (Bear in mind that anything the settlers produce for themselves can be exported at a price advantage to other in-space markets.)

[MMM # 3 MAR '87, "Moon Mall"]

[MMM # 77 JUL '94, p. 8 "Cottage Industry"]

Variety and diversity will grow exponentially as after-work cottage industry activities arise to serve the unquenchable thirst for the custom, the different, the personal, the truly beautiful. Street markets, at first hit and miss in both times open and space will become regular, then permanent, and grow from flea market caliber towards a satisfyingly department-store-like spectrum of selections.

As versatile food crops increase in number, menus and cuisines will diversify and a wide range of interesting eateries and the odors associated with them will soon become taken for granted. As the variety of musical instruments fashionable from lunar materials grows, the number of good street ensembles will mushroom, as the number of a capella singing groups diminish (e.g. barbershop quartets).

[MMM # 3 MAR '87, "Moon Music"]

The more consumer products, the greater the volume and variety of discard objects. Reuse and recycling sorting bins and exchange marts will grow.

[MMM # 34 APR '90, pp. 3-5 "Recycling"]

[MMM # 66 JUN '93, p. 9 "Encyclobin"]

Because capital production equipment as well as service facilities to be enjoyed by all will be expensive, less will go farther if used and enjoyed, as the case may be, around the clock. The settlement will work three staggered shifts without chauvinist preference for one over the other. With the solar clock set on 4 weeks instead of 24 hours, different streets and whole neighborhoods can have their own day/night lighting cycles.

[MMM # 43 MAR '91, p. 4 "Dayspan"; "Nightspan"]

The corollary is that the neighborhood-joining commercial, market, dining and entertainment street areas should be alive, vibrant, and interesting around the clock. Market stalls and cottage industry shops might be time-shared by coop members, or their goods sold round-the-clock by caretakers on a consignment basis. And always, the street will be the place to indulge in the universal pastime of people watching.

Whatever the part of 24-hour lighting cycle, settlement streets will take on a different personality and ambiance depending upon whether it is dayspan or nightspan out-vac. It is not only a matter of the availability or not of magically healing sunshine. The number of people on the street, their energies and moods, and the quantity of cottage industry goods available will all cycle with the local 29.5 day sunth. Many production employees will change from energy-intensive to labor-intensive jobs as night falls and with it the total available electrical power. Street activity cycles will follow suite.

[# 28 SEP '89, p. 3 "Choice of a Three Village System"]

Some landscaped areas will sport park benches for shoppers and workers on break to take a respite. Urban pocket parks work best if they are not secluded. People want to relax, yes, but such relaxation is enjoyed the more if it is in a peaceful spot in the full midst of the vibrant city bustle all around. Check and see: well-intentioned secluded urban parks are almost always relatively unvisited.

Role of the Settlement College /University

Any settlement institution of higher learning stands to play an enormous role in the development of the local culture and civilization and of the media and tools by which it is expressed. All this will be on display directly or indirectly on the streets. A university would assist on site companies in the development of new locally-sourced building materials,

appropriate architectural systems and construction methods. Its research may contribute to the appearance of new finish and decorative materials as well as an expansion of the available color palette. All this will affect the basic appearance of the pressurized street cylinder and its decoration.

University assistance in cottage industry formation will help speed the diversification of products available in streetside markets and shops; development of musical instruments fashionable from local building materials will have its affects on the sounds of the street; development of new plant hybrids will enrich and diversify landscaping options; the list goes on and on.

The Street as a Default Home

What about those temporarily or chronically unable to come up with mortgage payments or rent? What about those who are willing or forced exiles from homes that were dysfunctional so long as they remained in them? What about those overcome with mental disorders and disowned by relatives and friends? Lunar towns fly the flag of "Tanstaafl!" – "there ain't no such thing as a free lunch." Every pioneer is expected to be productive.

It may be required of all who would come, or of their corporate sponsors, to place in escrow funds for return passage to Earth in case they grow unhappy with settlement life or should the settlement becomes dissatisfied with them. This measure will take care of some of the problem and minimize the effects of economic dislocation and job loss. But people will still fall through the cracks that remain.

There is hard work out-vac, building roads and bridges over rilles, erecting habitat and other pressurized structures, mining, and other sundry field work tasks needing to be done if the settlement is to survive. It will be work that will attract some, but too few. Here then, is a niche for an out-vac service corps into which the temporarily or chronically dislocated can serve in exchange for food and lodging and the buildup of a nest egg for a fresh start, a fund that cannot be touched until it reaches a certain minimum. In addition, there may be in-city universal service type jobs going unfilled by the available youth pool (of say 18-20 year olds). There will be opportunities, too, to join other lunar and off Moon settlement endeavors, hard pressed for recruits (Mars, Ceres, etc.). Such efforts may oft' be sink-or-swim enterprises tending to shape up those involved.

Any such potential problem as homelessness must be tackled on many fronts. Prevention is vital. Vocational and occupational job counseling and retraining; pre- and post-marital counseling; parental and family counseling; crisis management; work schedule options; residence options, etc. Some of the bill for this work might be paid out of a tax on companies doing work on the Moon and importing workers and their families. The rehabilitation work might in part be done by OMOs, occupational maintenance organizations. What is needed is not job "insurance" (i.e. unemployment compensation) but job "assurance". But there remains leftover work and vocation aplenty for service clubs, religious orders, and churches.

Those still falling through the more stubborn cracks can be provided storage lockers for what belongings they retain, lockers to which is attached a legal address for receipt of mail, and for listing on job applications. This host facility might provide cooking facilities and showers. Use of such a facility will bring with it a requirement to participate in retraining and rehabilitation programs. This is in everybody's interest. Tanstaafl still rules!

The criminally misfit need to be handled in the same comprehensive way. We cannot afford to lose a person's potential productivity through money-, personnel-, and resource-sucking incarceration. Involuntary out-vac service corps work, as outlined above, should be the extent of punishment, as opposed to rehabilitation, repatriation to Earth, or reassignment to asteroid colony backwaters. [MMM #35 MAY 90, p. 3 "Ports of Pardon"]

[snip]

The Unfinished City

"Praise be the darkness, and Creation Unfinished!"

Ursula K. LeGuin in "The Left Hand of Darkness"

If any of us came into the world to find it, its culture, its civilization and cities "finished" we'd be at an intractable loss to find personal meaning or significance to our lives. It is because the world and the city is unfinished that it is both breeding ground for evil and an opportunity for good.

Urban planning must always remain tentative, confine itself to infrastructure and resist the temptation to divinely proclaim the details, stifling individual initiative and expression, suffocating the vibrant vitality that comes from unexpected spontaneity. The city is livable only to the extent that for each of us there is an opportunity to contribute our own individual "brick(s)". The off-Earth "Xity" [= a city that has to concern itself with creating and maintaining its own biosphere] is a shared undertaking of unprecedented challenge and scope.

As such the proposition to establish a "Xity" will attract architects and city-planners who would play god, deciding everything, reducing all who shall ever after live therein to lives the more meaningless because of the lack of opportunity to help finish the unfinishable city. It is only the unfinished city that lives, that is alive. Future off-planet cities, whether they be on alien surface scapes or within O'Neillian rotating constructs, must begin life only partially determined. This is a challenge foreseen, to be sure, by no science fiction/fantasy artist with whom I am familiar. Their cities are all uniform in architectural style and plan, all new (rather than a mixture of new and old) and inevitably gleaming, as if created not bit by bit like living world-challenged things, but all at once like some bauble in a bubble.

Enthusiasts captivated by such untrue-to-life artistic renderings may not make the best pioneers. The frontier will always have rough edges and the pioneer's calling is to smooth them down, one at a time. There will be no abracadabra cities out there, just frontier towns whose inhabitants will find their lives enriched with the real life chance to make a difference, to help finish the never finished.

Examine yourself, score yourself, and take another look! Because it is so very unfinished, the frontier settlement or city will be most rewardingly livable. To be sure, the great megastructure cities such as O'Neill colonies, proposed domed craters, vaulted rilles, the main "plaza" structure depicted by Rawlings in Ben Bova's "Welcome to Moonbase" are visually alluring and inviting. Their high ceilings allow expansive vistas within which individual dwellings and other buildings can be built using familiar construction methods to create Earth-mimicking urban environments. But despite their postcard-worthy panoramas, such fixed-size cities will quickly become vitality-suffocating unless they are somehow able to expand in modular fashion (as in the Prinztown study of vaulted rille sections built as a series of villages in multiples of three*. The discussion is moot, however, for in the near term, only modular lunar and space settlements can have realistically affordable construction and early occupancy thresholds.

<MMM>

MMM #128

Defining Home Rule for Settlers

[Once "Enough People" are Living & Working in Space, on the Moon, or Mars, "the question" will no longer be so easily brushed aside.]

A Preamble -- to the Discussion

By Peter Kokh

Discussing the Political Future and possible Political Regimes under which settlements on the Moon or Mars, or in space itself can grow and thrive on the Space Frontier is a dangerous question. It would seem to be one big can of worms. This is one area in which emotion,

temperament, and upbringing often have much more to do with our “world views” and expectations than does reason or thoughtful discourse. Any sort of consensus seems remote.

We space supporters come from all political persuasions. Not all of us are Republican, though those who are seem to think so. Not all of us are libertarian anarchists, though those who are seem to think so. Not all of us take it for granted that all of space should be annexed to the United States, new state by new state. But those who do seem to think so.

Once there is a critical mass of pioneers on the space frontier, they’ll inevitably decide their own future, and the political conditions under which they will live. I am sure that supporters, in Britain, France, Spain, and Portugal, of the opening of the New World of the Americas, took it for granted that their own national flags would rule forever. They were wrong, and the ultra-patriots amongst us need to take heed. Once (if ever, you sniff) there is a critical mass of pioneers on the space frontier, they will inevitably decide their own future, and the charters or constitutions under which they will live.

To American Patriots who would make the Moon, or a hemisphere of it, the 51st state, we need only remind them that this would make our own Founding Fathers, who fought so hard to free themselves from the British Crown, turn over in their graves. Nothing could be more Un-American at its core, than this so-called American solution.

But why, you ask, would governments on Earth put so much money into “colonies”, if they knew that they would one day become free? First easy answer is that they are, fortunately for the settlers, too naive to realize this, or think it can be prevented by Enlightened Paternalism. But those who do take the long view will see this support as hopefully paying off in the creation of viable new markets and stable new trading partners that will benefit the homeland.

Whoa! Let’s back up a bit! We may never get that far in space. Sure an outpost or two, and some industry, but enough people to make viable nations? We have enough of this ridiculously nonviable little island nation nonsense in the U.N. as it is!

Well, we broached the “ultimate solution” case of independence -- only to show the direction down which this discussion is meant to take the first halting steps. Let’s leave for the future what only the future can decide. But that some sort of decision of this sort may someday be inevitable must be kept in mind, as we take first steps.

The First Step: Defining the Conditions, Stages, and Thresholds of Increasing Levels of Settlement Home Rule

Now there’s a more pragmatic frame to the questions we propose to discuss – hopefully with considerable input from our readers – in the next issue or two (or however, long it takes) of Moon Miners’ Manifesto.

What I am calling for is a discussion that will advance a consensus on what language should be included in a Civilian Enterprise-based Settlement Charter. I was in my twenties when the European “Colonies” in Africa and Asia achieved their independence. I was living in England in 1960–1 when the British Home Secretary was charged by the government with coming up with intricate home rule arrangements that “protected” the European Settlers and guaranteed them a voice, even though they were most often a small minority. Some of the resulting agreements were most complex, anything but straightforward. I was a studious observer of it all. And to this day, I remain a firm believer that a horrendous amount of trouble and strife can be avoided by the up front design and adoption of Settlement Charters which spell out how “home rule” “will be automatically granted” in a “step by step fashion” “as listed thresholds” of economic and institutional development and of population and economic growth are reached.

If these thresholds are never met, then so what? Everyone knows what the rules are, everyone agrees to them. Political uncertainty is greatly alleviated and in such a climate,

economic investment and development, and individual and community planning and life-decisions can be best made. <PK>

MMM #129

[CONTINUING A NEW MMM SERIES: Once “Enough People” are Living & Working in Space, on the Moon,]

The HomeRule Question

THE HOME RULE QUESTION

By Peter Kokh

Origins of Civilian Rule and a Domestic Economy

First let us say that this discussion is not about the political evolution of “Company Town” settlements. Some see that as the logical, perhaps the only logical situation. I have seen company towns, and the overwhelming majority of them are not healthy places to live no matter how well maintained. It is important that we work to put in place a regime by which all towns are civilian. The best way to do this is by ensuring that towns are begun as multi-party joint ventures, in no one boardroom’s pocket.

- Earth–Moon transportation companies
- Mining companies
- Materials processing companies
- Construction companies
- Communications companies
- Bower utilities
- Export–import companies etc.

It would seem more of a stretch of imagination to believe that one and only one company will be all these things than to expect that opening the lunar frontier will be a synergistic affair between several. Even if there is a joint venture between several of the companies involved, there will also be subcontractors and then, Voilà – a civilian situation. If there is more than one company in town, individuals will have some bargaining power. It will be logical to create a civilian authority separate from any and all companies (not necessarily resistant to pressure) to maintain civil order and regulate the interactions of individuals, some employed here, some there. There would be a constable of sorts and a judicial administrator at least. Some decisions could be tele-judicated from Earth, but that won’t sit well for long. Even if civilian authorities are appointed by powers on Earth, once there services are needed on a regular basis, it is likely they will be living on the Moon and part of the settlement.

Civilian Authority is not necessarily home rule

This by itself is not quite “home rule” – in fact, civilian or not, authority may be quite colonial at first, not even consulting local residents, though that will inexorably invite trouble. The sponsoring national powers on Earth will have their agreed upon policies, (no marriages, no private ownership, etc.) many of them favoring the big companies involved.

Resentment of one such policy or another may be the first seed of a drive for more resident responsive government. A resident advisory council is a cheap fix sure to be tried first. The recommendations of an advisory council can be ignored, or met with promises there is no intent to keep. The council would serve its purpose of allowing pioneers to vent off steam and frustrations. But it’s a foot in the door.

From such beginnings there would seem to be many milestones on the road to “home rule”

- Elected advisory representatives
- Elected legislative representatives
- Elected executive (mayor, governor)
- Local courts

While these are the obvious milestones, do not forget how important a factor a bureaucracy can be with life of its own, even in advanced independent democracies such as our own. It would be most efficient for companies to operate in a paperless fashion on the Moon, exporting all desk work electronically to “cheaper” help Earthside.

This saves people on the Moon for the more productive and constructive tasks and will accelerate the growth of the local economy instead of acting as a drag. But once the settlement is big enough to take over such chores, you can see that it might become an issue, not that local bureaucrats will prove to be anymore responsive and helpful than absentee ones.

What “Home Rule” is and isn’t

Home Rule is not independence. The American states have more than home rule. They have sovereignty of a sort. But they are not each independent, they share independence. Puerto Rico has home rule. It can govern its own schools, decide what language will be the currency of public business, pass its own laws, do anything at all except print money and have a military or conduct foreign affairs.

In Robert A. Heinlein’s “**The Moon is a Harsh Mistress**” and Ben Bova’s “**Millennium**” early lunar outposts went straight for independence. Logically there are intermediate steps, and a steady progress from one through the next is in everyone’s interest. Look at what happened to African and other colonies which were summarily freed without preparation and establishment of a sufficient set of local institutions.

The Critical Question

The question is this. Should this process be left to chance, perhaps in the hope it will never happen, or that the settlement will never amount to much? Or

Should we agree upfront on an amendable course of progress with ever greater degrees of home rule granted as the settlement reached pre-agreed goals of population growth, economic and industrial diversification, effective self-sufficiency in education and health care, so many months stockpiles of critical reserves of parts, fuels, food, etc., such and such progress towards break-even between exports and imports?

We’ve seen untold strife in the 60’s and since because of the lack of such pre-agreements. We need not make that mistake on the Moon, Mars or anywhere else. <MMM>

*We, pioneers of Luna,
in these words here writ,
do declare that*

A Pre-Settlement Charter for the Moon?

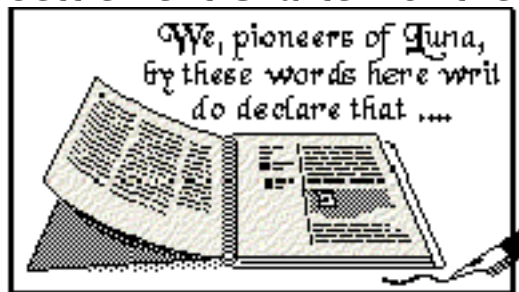

By Peter Kokh

A Lunar Constitution is quite a ways down the road. What we are proposing is to prepare a trial “pre-settlement charter” for any prospective outpost that could conceivably become a

full-fledged settlement, spelling out stages of “activation” by which “x” amount of growth and “y” steps of achievement will be rewarded by increasing degrees of local control. Outposts will hopefully be in the plural. And if they are, they will be like seeds sown elsewhere. Some will fall on barren ground, fail to germinate or sprout, and become ghost towns. Others will sprout up but not flower. A few may self-propagate into full fledged settlements, even becoming real cities. Is this unrealistic? We think not.

Those who demand that lunar settlements justify their existence on the basis of “one product” before we consent to proceed further without the government holding our hand and picking up the tab, are proposing a test that has been demanded of no settlement before. [We think of Gordon Woodcock’s pessimistic assessment of lunar industrial potential a few years back as well as of the NSS challenge for papers for ISDC 2000, which seems to buy into several unjustified and unmentioned assumptions. Engineers and lawyers make good money, not good economics.]

Ninety percent of any economy is domestic, powered by the production of goods and services for local consumption. Would it have made sense to hold up the ships bound for the Americas unless the would-be pioneers could first prove that they had one and only one product in mind that they could make in the New World and export back to England or Spain in enough quantity to earn shipment back to them of all their needs and supplies? That is the a priori test some would apply to any commercial for-profit lunar enterprise. It is best just to ignore it, not trying to prove what they cannot understand. Just do it.

Back to that ninety percent. Of the remaining exported sum of goods and services, another ninety percent will be to other space markets (not unlike U.S. to Canada and other North and South American nations as opposed to mother England).

The lunar economy will grow apace with the economy in LEO and perhaps apace of efforts to tap asteroid resources and efforts to open the Martian Frontier. Only the combined space economy as a whole must pay its way with a positive trade balance with Earth. And in that equation, LEO is part of the space economy. With terracing and step by step industrial and commercial diversification, we see no reason why the Moon itself cannot someday support a population of hundreds of thousands, or more. In contrast, those who forget (or never learned) how economies are put together can only foresee highly subsidized outposts of a few dozen people at best. And the extent of their activism is to get “George” Government to pick up the tab.

Charters for a Plurality of Settlements

Already some will have realized that we must address two questions, not one.

1. When should an outpost on the road to becoming a settlement be granted how much local rule, and
2. When does the entity we are dealing with cease to be individual settlements and become a self organizing frontier association of settlements?

My suggestion a few years back that independence was something that should be considered only for a multi-settlement frontier that by virtue of its plurality had put itself on the road to global occupation of the Moon or Mars was greeted with derision by Jim Davidson. But in the light of all the unviable island entities we have recently welcomed into the United Nations, is this an unreasonable standard?

It is much less likely that stand-alone lunar settlements could achieve economic self-sufficiency than a cooperative interdependent, inter-trading association of settlements. That’s just common sense.

In the ranks of space activism, we have always had a strong anarchist-libertarian constituency for whom space is attractive primarily because it opens up the possibility of just such a proliferation of small independent worldlet principalities thumbing their noses and right middle fingers at the rest of the universe and at economic reality. Historically, however, dictatorship becomes more likely in proportion to the economic absurdity involved. Big does not always mean tyranny. Small doesn’t always guarantee freedom. The settlers will decide this issue for them-selves. It is not ours to get hot and bothered about.

On Earth, “one world” and “one world government” are seen as the only rational option by some, and as the most diabolical of solutions by others. But here individual nations and tribes have history and inertia. On the Moon or Mars, where we are “starting over, starting fresh,” and where the enemy may be off-planet rather than on, the pioneers will find themselves free to take a second, no baggage look.

Higher goals and economic reality

Meanwhile it makes sense for us to encourage settlements and outposts to seek economic viability in association with one another, not separately. A properly defined and terraced (sequenced) set of milestones defined in a charter agreement will reach a level of demand that may be very difficult (though not impossible) for a solitary settlement to reach, but within the easier, timelier grasp of a cooperative association of settlements. Two examples:

- A full-fledged university
- A major hospital

That the settlement(s) will be both educationally and medically self-sufficient are reasonable standards for higher levels of “home rule” activation. In today's world, which is getting ever more complex, it is estimated it takes a city of a quarter million people to produce 95% of its own needs. On the other hand, it is not necessary to produce all your own needs, only to produce enough to sell to earn the money with which to buy everything else. It is reasonable for the sponsoring powers and agencies to demand attainment of a certain demonstrated level of sustainable economic viability, before agreeing to remove all supervision and over-sight. Even today, many nations must surrender the exercise of certain sovereign prerogatives to meet the demands of World Bank lenders.

Actually, “independence” is an illusion. As the economies of all nations continue to globalize, “inter”dependence is what we enjoy, whether we wish to admit it or not.

Back to the Question:

Do we begrudge the pioneers their political autonomy, fighting them every step of the way, thus forcing them to win their rights in a test of power, management-union style? Some, by temperament and prejudice, will prefer, counsel, and demand such a strategy in the hopes of securing financial self interest as long as possible, delaying the inevitable..

Or, do we lay out a roadmap, locate the mile-stones, and declare the rewards of attaining each. If the proper role of government is to provide a fair set of rules and a level playing field on which all free persons can pursue “life, liberty, and the pursuit of happiness” without further interference, then such “roadmap charters” with staged phases of automatic home rule activation fall within that enlightened mandate. Brainstorming the possible particulars, the forks in the roads, and what prerequisites must be met for each higher stage of home rule is a project in which I invite all interested readers to participate.

If we leave this to government, we guarantee a nonsensical result. Nothing rational can be produced when political compromise over non-germane issues is the prevailing standard of agreement. That is why we have a shuttle that is less capable than it could be, and are getting a station of similar mongrel breed.

Nor is it in the proven area of demonstrated corporate talents to come up with such documents. This must be the work of a pioneering people. We who would prepare the way for the actual pioneers, are those pioneering people. We must do it, or it will not be done, with the chaos of anarchy the likely result.

A word to contrary minds

We have asked a question, and we know that many will answer in the negative. Those who identify with company management may tend to see the pioneers as employees and consider “home rule” measures as something they should have to bargain for in a test of wills and power. As one who has spent many years in industry, I feel that the arrogance of management is the principal demotivating cause of poor employee performance. The attitude is counter-productive from the start. But why argue if you are a mind-made-up proponent of the opposite view. Most pioneers may be “employees,” But when it comes to civilian rights, it gets

no one anywhere to reduce them to that. It solves nothing to start off with the same stupid “adversarial mentality” we find in management labor relations in this country.

Let them earn it, you say. I say so too. But then it is fair to preagree on what performance earns what rewards. If circumstances and situations change and show that the “schedule of progress” is unrealistic, too fast, too slow, too jerky, whatever, there should be a proper means of amending it.

In the past, in all situations of political process I know of, especially throughout the whole global decolonization period, every step had to be negotiated – or fought. There has always been a succession of regimes, of charters, of constitutions.

I suggest that this is neither necessary nor advisable. One charter could do it all if it is fully and clearly spelled out that these conditions being met, this would be the degree of home rule. Make more progress toward pre-agreed goals, get greater degrees of self government including the right to establish a bill of rights, a division of powers, and other features we normally relegate to a constitution.

Should the outpost never become more than that, no problem – it’s all spelled-out. Everyone knows the rules. If a settlement comes into its own and thrives and spreads beyond expectation, the charter provisions are in place to guide it. Revolutions of independence can be avoided. They cause a lot of damage that can take decades to undo.

The foregoing is just a generalized expression of the approach I think we need to take. There are a lot of unanswered questions. We can start identifying the questions, not trying to answer them right away. And I hope that many of you readers will get involved and help identify more questions, more problems, more possible approaches. Who knows maybe we can produce something.

We are not yet talking constitutions, nor yet discussing a Bill of Rights, nor the division of powers nor how the legislature be constituted – we can eventually propose and advise, leaving it to the pioneers to choose. What we are doing here is brain-storming presettlement charters that will govern the pioneers’ political progress towards maturity. <PK>

Self-sufficiency Tests & Goals



By Peter Kokh

We’ve already hinted at some not directly economic things that might be considered as bench marks of pioneer and frontier achievement “meriting increased home rule”:

- Increases in population, e.g.: 100, 300, 1000, 5000, 25000, 100,000, 250,000, one million
- Educational capacity: K12, technical college, full university (list of critical departments), degree of involvement of the university in creation of new enterprise and in increased industrial diversification, involvement in arts and craft media development, fractional gravity-sensitive performing arts, etc.
- Medical capacity: capacity to treat most trauma, common diseases, pediatrics, maternity ward, etc. advanced capacity: neurosurgery, oncology, etc. (advances counted in reduction of the percentage of cases that must either be sent to hospitals on Earth or left to die as comfortably as possible) medical advances in the area of lunar-peculiar medical problems
- Progression from an all worker society towards the normal mix of working adults, children, and seniors given productive roles suited to their slowly diminishing capacities
- Progression from a one settlement operation to an actively inter-trading association of frontier communities with consequent growth both in domestic and export economies
- Increases in the ratio of native Earthborn individuals electing to stay in comparison to those still rotating back to Earth
- Increases in the proportion of native born Lunans

- Ongoing assessment of the comparative health of native born Lunans over several generations
- Diversity of the gene pool (another article)

Balance of Trade Questions

Balance of Trade QUESTIONS

By Peter Kokh

The following additional items are vital because they affect the economic viability equation:

- **S**tockpiles of critical imported reserves (volatiles not yet produced in enough quantity locally, emergency food rations, parts for essential equipment, backup power units, etc. etc.) e.g.: 6 months reserves, 12 months, two years
- **I**n creases in percentage of architectural and building products and units manufactured on the Moon versus imported from Earth (increases in the degree by which population expansion can be wholly supported locally)
- **I**n creases in the percentage of food and other agricultural products grown locally both in terms of total tonnage and in diversity (progress towards a locally supported diversified foods menu)
- **I**n creases in percentage of total mass of products manufactured on the Moon in comparison to the total mass of products that must be imported from Earth (reductions in import dependency)
- Increases in the number, relative worth, and deferred import value of new lunar sourced “substitution products” to replace items that had been imported from Earth because equivalent products could not be manufactured from commonly available lunar materials
- Increasing levels of industrial and commercial diversification (economic insurance against the vulnerabilities of one export product economies)
- Increases in the percentage of exports sold to other space markets (including LEO and GEO) in relation to those sold directly to Earth.
- Increases in the diversification of products sold to other space markets
- Increases in the percentage of imports from other space markets in comparison to those coming from Earth (these last three considerations will indicate the degree of integration of the Lunar economy into an emerging wider solar system economy extra terrestrial sector.)
- Growth of a local machine tool industry
- Growth of a local electronics industry
- Growing percentage of surface vehicles, for out-vac and inhabitant use with majority (by mass) content locally manufactured
- Growth of spacecraft servicing and reoutfitting capacity <MMM>

MMM #130

A Bill of Rights for Space Frontier Constitutions

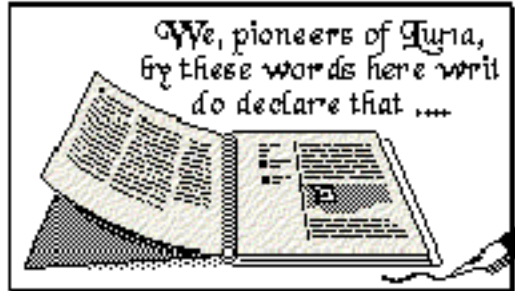

By Peter Kokh

What can we take for granted?

No part of the U.S. Constitution seems more quintessential to our way of life than the "Bill of Rights". Yet actually, it was an afterthought. After the rest of the language of the Constitution had been drawn up and met with the framers consensus, all the questions about the structure of the government and the division of powers seemed to have been answered. Then it was noticed that the document did not address the relationship of citizens to one another or to the government. The absence of a statement on these rights was handled by a set of ten amendments. The Constitution with these first ten amendments was then voted on and approved as a package.

Lesson learned, framers of any space frontier constitution need to address individual rights in the same package as they attend to organizational matters and the division of jurisdictions and the schedule for achievement-triggered levels of autonomy. But it may not be so simple a matter of just tacking on our own Bill of Rights.

First of all, these present ten amendments have led to two centuries of legal squabbles about how literally or freely they must be interpreted. There will be many calls for rewriting them in language that is clearer about the intent in which they are to be each applied. We will bring up some of the points most in contention.

Secondly, some of the succeeding amendments further clarified individual rights. And Supreme Court interpretations have generally served to strengthen individual rights against those who were happier with those rights being unestablished.

More to the point, on the Space Frontier we will be dealing with the rights of people in a wholly new, unprecedented, and never imagined set of circumstances which arguably changes everything. For the first time we will be talking about individuals who do not live in a pre-given worldwide life-sustaining biosphere. We will be talking about the rights of individuals living in artificially established and maintained mini-biospheres that are local in character, and outside of which, whether on hostile planetary surfaces, or in the void of space itself, life cannot be sustained. Such situations have never previously existed. Thus they have never been addressed. It is the writer's contention, that the "Space Frontier Condition" changes everything, to one extent or the other.

No government on Earth need guarantee, either in its constitution or in subsequent legislation, the right to air, water, sufficient heat so as not to freeze to death, and even food. Except in the most extreme weather, most people can survive out in the open for quite some time, even indefinitely. On the outside you will still find air to breath, water to drink and, if you know how to forage and/or hunt, food. The resourceful person can also find warmth. Put outside the airlock, without the provision of countermeasures, no one can long survive on the space frontier. We're all in it together, and our common humanity decrees we all have rights that it never occurred to anyone to define and guarantee.

"Lifeline Services"

On the space frontier, the distinction between "indoors" and "outdoors" lists the options neither accurately nor completely. There is a great gray area which from one point of view is "outside" – at least outside individual private or public structures, and which from another point

of view is “inside” – inside the biosphere containment hull, shell, dome, or whatever preserves the common life–sustaining barrier against the exterior vacuum or unbreathably thin and/or unbreathably composed alien atmosphere. Both inside and outside become ambiguous.

Nearly thirteen years ago, in MMM # 5, MAY ‘87, we introduced the term “middoors” for common spaces within the Biosphere containment shell as opposed to “indoor” spaces within private homes and private and wall–defined buildings, etc. Later, we introduced the word “out–vac” (modeled, of course, after the Australian word “outback”) for the airless environment outside the biosphere airlocks. [On Mars we might substitute the word “out–gasp” :-)]

Although I can think of a lot of people who’d be excluded by their “devil–take–the–hindmost–because–I–knowhow–to–get–mine ” mentality, it would seem to me that most reasonable people would come to agree that we must address three things:

- An individual’s right to remain within a biosphere, once he/she is in, with the burden of finding alternative residence possibly resting upon the biosphere’s authorities
- An individual’s right to be homeless within a biosphere’s common middoor spaces, with the burden of finding alternative residence possibly resting on the biosphere’s authorities
- An individual’s right to basic life–sustaining utilities within a private residence whether or not he/she can afford to pay for them

Now we can discuss all we want where rights end and responsibilities begin. But we must never forget that we are not talking about Earth. We all strongly prefer to have only responsible, industrious, contributing citizens on the space frontier – no dead–weight, thank you. But we’ve all heard, and hopefully had the occasion to say with sincerity the humbling phrase “There, but for the Grace of God, go !!”

While not all of us have ever been “down and out,” we all know that someday we could be. On the space frontier that is a condition enormously more threatening. Unless we establish a regime of rights and responsibilities to address unfortunate circumstances.

Now a constitution might keep its language general and simply state that any individual has the right to remain within a settlement’s biosphere pending the location of a non–life–threatening option; that any individual has status within the settlement’s middoor commons without restriction to those having established indoor residences; that any individual has the right to minimal hook–up biospheric utility service to his/ her place of residence. The P’s and Q’s and the crossing of the T’s and dotting of the i’s can be left to subsequent legislation.

But here is a list of “life–sustaining’ services and rights that I will throw out to get the discussion going:

- No cost “indoor” temperature control within the range set for middoor common spaces, e.g., free heating up to 50 °F or 10 °C and free cooling down to 85 °F or 30 °C (arguable but reasonable)
- Basic “safety” level lighting
- Fresh water in (a “reasonable” ration), waste water removal
- Fresh air in (“reasonable” rate of flow ration), stale air out
- Access to food at both no and low cost. Right to grow food in community gardens. Right to “staples” and a share of “seconds”
- Right to minimum outbound communications free calls to public officials, health authorities, emergency hot lines business subsidized free calls to advertisers caller–paid incoming calls
- Right to volume–rationed free storage for personal effects
- Right to rationed–access public bathing/shower facilities/laundry
- Right for traditional or non–traditional family groups to be relocated together
- Limited right to education, training, retraining
- Limited right to handicap challenge training
- Limited right to Entrepreneurial technical/business assistance
- Right to Occupational services, retraining

- Right to basic Educational services
- Right to Universal service training and placement opportunities

This is admittedly a long list. It is not aimed at giving away the farm, or giving people something for nothing. Extension of these rights would be a calculated risk to ensure that everyone remains productive or has every opportunity of recovering from misfortune to become productive and useful again. It is neither in the common interest to allow the creation of a homeless class of outcastes or untouchables, nor to settle such problems “cheaply” by putting the unfortunate “outside the airlock.”

These provisions are aimed at minimizing as far as possible the number of settlement “residents at large” with no home other than the middoor streets and parks and other common spaces. Finding ways to keep people in homes and with access to the means of getting back on their feet is in everyone’s interest.

Other Issues – comments on basic freedoms

- Refining the separation of Church and State: We should be careful to assure the right of and from both religion and culture. This right should not be interpreted so as to deny equal educational access and tax-paid common tools to those who do not wish to subscribe to the common culture.
- Mindful of the need of space settlements to control expensive imports, especially in areas where there are substitution alternatives, governments may be inclined to take advantage of their prerogative to establish import protocols to restrict the right of individuals to own non-electronic forms of books, papers, and other knowledge packages. With such a stricture might come the temptation to “censor” or otherwise restrict incoming electronic memories. Perhaps this would not be a problem. But should a constitution specifically guarantee “the right to own books” etc. and other repositories of information, art, imagination, and expression? It couldn’t hurt.
- One of the unestablished rights over which there is now much debate, is the so-called “right to die”, with assistance where necessary. Will some practical consensus be reached in coming years?
- Should a person on the space frontier be able to exercise “the right of exile” or of repatriation in preference to incarceration? These options of “removal” from the free population might be cheaper.
- Should “the right of travel” be guaranteed?
- The “right to work past retirement age?”

There are other debates about rights that I have not mentioned. Email me about glaring “omissions” kokhmmm@aol.com

Nor have we addressed the question of constitutional “Duties & Responsibilities.” Perhaps we will venture into this danger fraught area in Next Month’s MMM!

Discussion is open. <MMM>

A Century on Antarctica and what have we got?

Is this where we want to be on the Moon and Mars after our first century on those frontiers? Antarctica is a bad precedent we allowed to happen. We need to give a hoot.

Transportation: Ports & harbors:

None (offshore anchorage only)

Transportation: Airports: (1997)

39 locations with 33 having heliports. Runways at 13 locations are gravel, sea ice, glacier ice, or compacted snow surface suitable for wheeled fixed-wing aircraft; no paved runways. All are government operated except two facilities owned by non-governmental commercial tourist organizations.

Economy—overview:

No economic activity at present except for fishing off the coast and small-scale tourism, both based abroad. There are no “on continent” facilities or installations in support of tourism

Causes of slow progress:

Through collective inaction, Antarctica has been abandoned to government activity. Through collective apathy, a Treaty was agreed upon that serves as an extreme damper on economic activity. ###

MMM #131

For “Strangers in a Strange Land,” A “Right” of Repatriation?

By Peter Kokh

Does anyone know him/herself truly well enough to volunteer to be a “one-way” space pioneer? Should immigrants have a right of repatriation with guaranteed free passage back to Earth, should it become clear that they just can’t handle frontier life? How would reserves to pay for this be set aside?

Every effort must be made to exclude those likely to fail; to be sure those still willing enter into this with eyes wide open. On past frontiers, the immigrants gave up the old country, relatives, friends, property, etc. They did not give up Earth, its blue skies, the green grass and forests, the fresh air, outdoor activities – in short they have never before given up life in the Mothering Earth Biosphere.

There is much “romance” in the notion of pioneering new worlds. We must do everything possible to minimize this romance if we are not going to end up with a lot of disillusioned and mutinous settlers. People have to know what they’re giving up. And they have to be confident that what they are gaining is worth it; to believe that they will have every opportunity to make steady improvements in harsh living conditions. Would the right to return home, prepaid be an effective safety valve to diffuse trouble? Or would this safety valve work instead to encourage people to try, when really they are not suited?

The likeliest scenario is that the first space pioneers will be persons who have gone out to work, with no intention of staying. Among those who agree to stay on will be some who have fallen in love with the frontier, eventually becoming so comfortable with their new life that they are ready to give up the right of return for a “buy-in” into the frontier as a citizen. But should the Earth-based employer decide to pull up stakes, leaving the starter community high and dry and unviable, they might be required to offer free repatriation as an “ultimate assurance”.

Once a settlement is begun with former on site temporary employees, the opportunity for direct immigration from Earth will arise. Here, volunteers, job contracts in hand, will be making “for keeps” decisions without actual experience of frontier life, even if they have passed their “frontier orientation simulations” with flying colors. If hiring companies are involved in the orientation and simulation as “assurance” against recruiting unsuitable persons, then they should be able to purchase “insurance” to pay the cost of return of the hopefully few pioneers who will fail despite all their best intentions.

Now for Lunan pioneers, this cost will be modest relative to the cost of repatriating Martian pioneers. This is a plus for having frontier opening experience under our belt on the Moon first. <MMM>

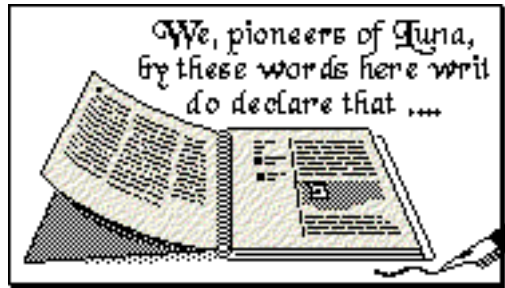

The Settlement as an Intentional Community

By Peter Kokh

We know the origins of some of Earth's cities and towns. For most others, their origins are lost in the myths of time. Yet with few exceptions (planned capital cities like Washington, Brasilia, Islamabad, Canberra, etc.) cities have grown haphazardly, with no force shaping them other than topography (coasts and rivers, mountains, etc.) and the fortuitous conjunction of economic forces and fortunes.

Of "Xities" and "Reclamation"

In our series on extraterrestrial settlements MMM's #s 52-60, we coined a new word for communities that do not arise in a preexisting global biospheres, but which have to provide, and maintain, mini-biospheres of their own, with no forgiving "sinks" to act as buffers for environmental irresponsibilities. The word we offered was "Xity", "X" standing for "exo", of course, but pronounced hard: "KSIH tee," not "ek sih tee." We want the word pronounced in two syllables, like city, not three. The hard sound is a clue to the unprecedentedly difficult task that any/all settlements beyond Earth's cradling and coddling planet-wide biosphere must face.

Dutch towns below sea level come closest as a model. Their protective dikes holding back the tides and surges of the sea must be religiously maintained. The dike is an analog of the seamless pressure hulls of space settlements (modular or megastructure). The pressure hulls in effect "reclaim" from the seas of space, vacuum, and cosmic radiation, formerly "inundated lands" that are now made fertile, capable of supporting life. As we've said before, "reclamation" is job one for any space frontier settlement, a job that never ends. With eternal maintenance and vigilance, the reclaimed area hopefully will increase in size, fertility, productivity, and population.

Education Responsibilities in Fragile Biospheres

This "defining" "task one", means that the settlement cannot take a laissez faire attitude about the environmental education of its citizens, when it comes to awareness of their shared vulnerability and the responsibilities that each must assume as his or her own. The critical difference between the global biosphere that terrestrial cities take for granted, and the local mini-biospheres that space frontier settlement cannot ever take for granted, is that the latter have no massive "sinks" to buffer the effects of environmental sins and episodes of carelessness. On Earth, we mess up and it affects our grandchildren. Out there, we mess up and it's all over. The pioneers will live immediately downwind and downstream from themselves. Everyone, not just some, must care.

Luna City: The Developer's Role



The "Developer's" Role:

Putting together a package to attract anchor tenants and a “viable mix” of other clients, splitting costs & burdens, may be just the “accelerant” needed to start Lunar Development in earnest.

By Peter Kokh

Improved Real Estate

Most readers will be aware of the distinction between “improved” and “unimproved” real estate. “Improved” real estate has on site or boundary access to utilities like water, gas, and electric. The lot may or may not have other “improvements” e.g. drainage grading. “Unimproved” real estate is just raw ground, with no utility access, perhaps not even road access, the kind of stuff Florida and Nevada fly-by-night “developers” want to sell you in the middle of a swamp or desert for a “bargain of a lifetime” price/ Lot’s of luck doing anything with it!

All lunar real estate is “unimproved”

That does not mean that some locations are not better advantaged than others. Polar sites may have access to water-ice reserves. Highland/Mare Coastal sites have access to both major suites of pre-pulverized (read “pre-mined”) regolith. Sites along the Mare Imbrium rim are richer in Potassium and Thorium and KREEP elements. And so on. But these are natural assets. No land on the Moon is man-improved, i.e. with utility access, or with any other kind of location-location-location traffic generating engineered “improvements.” This is a daunting, if not intimidating fact facing anyone who has a free enterprise idea for a lunar location. The same can be said of Mars, of course.

Allen Wasser has proposed a lunar “land grant” program to attract lunar development. But perhaps the only ideal customer for such a real estate regime is the “developer” who will go into the prospect site and make improvements that will render it especially attractive to specialized mining, processing, manufacturing, and other types of private enterprise. The first such developer to “improve” a resource-rich well-situated site, may, in the process be founding the first genuine lunar settlement. Even if there is already a scientific outpost on location, without improvements the “settlement” will not come.

The perspective of other interested parties

The mining company, the manufacturing company, the hotel operator, do not want to have to do such unaccustomed preliminary work as setting up power supplies, providing water, building a space port, providing communication relays, etc. If these things were already in place, ready to “plug into” and ready for “hook up”, the location would be immensely more attractive. Industrial and commercial enterprise would not have to assume the extra burden of paying for these improvement costs up front, but would merely tap in, and pay a monthly or annual usage charge: utility bills. This drastically cuts their financing costs as well as the time between arrival on the Moon and first returns on investment. It makes their job in closing a deal at a bank that much easier, more realistic.

The Lunar Site Developer’s tasks:

(1) Picking a Site for Improvement:

The first task is to analyze candidate sites on the basis of “strengths & weaknesses”. The developer should draw up an “Existing Conditions Map.” This will include the topography within the area, noting potential obstacles and assets for construction. If there is a science outpost already established, any sharable assets (power, communications, roadways, launch pad) should be noted.

Do assets outweigh liabilities? Are there any “targets of opportunity” such as proximity to uncommon but valuable resources, passages through topographical obstacles such as passes through nearby ridges, natural bridges over nearby rilles? Are there known intact lavatubes in the vicinity? What is the ratio of highland-derived to mare-derived soil in the local regolith? Are

there scenic highlights in the area? Is there enough flat terrain for emplacement of large solar arrays? Is there a logical location for a spaceport?

What are the liabilities? Lack of easy access to neighboring areas of the Moon? Uneven terrain? A large number of inconveniently placed boulders? Rilles or ridges that are not easily negotiated? Such liabilities must be weighed along with assets.

Next the developer needs to brainstorm this mix of assets and come up with a winning strategy to attract enterprises to buy in the development.

(2) The Site Development Plan

Site development plans should work with the lay of the land, develop topography suggested transportation corridors in the vicinity. The location must be picked for the spaceport with adjacent surface warehousing and shipping/ receiving areas. Will the spaceport provide loading and unloading equipment so that incoming freighters do not have to carry the extra mass of self-unloading equipment? Developing the Port Facility will be part of Phase One.

A graded Road Network linking identified industrial park properties and residential and commercial areas and other special identified use areas must be provided. Easily gradable roadways to important nearby off-location resource-rich areas should be identified and marked. Care must be taken that all such identified sites are easily serviceable both by road and by utility providers.

3) Financial Considerations:

The proposed development must be

- **Market supportable**
- **Physically doable**
- **financially viable**

To this end, the developer needs to take on “natural partners” in order to subdivide the task and conquer the load. “Natural Partners” will include:

- A power generation company (solar &/or nuclear)
- An **oxygen production facility**. Among potentially competing proposals, one that employs processes that produce enriched tailings especially attractive to other potential manufacturers should be given the nod. Such beneficiated byproducts will help identify and attract other clients.
- A **water production facility**. If the site is not proximate to polar ice fields, and the developer does not wish to co-develop such icefields along with a means of transporting water, or hydrogen produced from it, to the development site, then, if hydrogen produced by heat-scavenging of any and all regolith moved in development of the site does not produce enough to be reacted with locally produced oxygen to meet needs, the balance must be brought from Earth

The only rational way to meet primary water recovery and waste treatment needs is on the spot where the water is grayed. This will be a burden each tenant-client of the development must assume. The development’s shared mini-biosphere must be modular both in construction and in maintenance. This means primary treatment at the source of the problem for both water and air.

- A **mining processing-building component manufacturer** to turn out prefab modular building components to fit customer needs, in order to defray the cost of bringing additional pressurized volume from Earth at much greater expense.
- Such a partner building component manufacturer could then enter into a joint venture with the developer to produce “turnkey” factories, warehouses, commercial and residential properties for other clients on the basis of need and request.
- Additionally, such a company could construct “hanger sheds” or space-frames constructed of glass composites or steel, covered with plates of the same material, then over-blanketed with regolith to provide “improved” radiation proof “lee vacuum” for easy set up of

modular habitat structures, especially less expensive, lighter, cheaper to ship inflatables and hybrid rigid-core inflatables (on the TransHab model). Such hangers or ramadas might be built as rille-spanning vaults: virtual man-made or more exactly, man-restored lavatubes, which is what most sinuous rilles originally were.

- Another joint venture would be to provide improved access (graded ramps and elevators) to any buildable lavatubes in the area. Shafts drilled through the lavatube ceiling/roof filled with fiber optic cables, with sun collector on top and light defuser within the lavatube, would be an immensely attractive improvement, as would be a lavatube floor topographic map. No enter-prise will buy space within a lavatube, no matter how many theoretical advantages it offers, without solid concrete information, and prepared access and minimal lighting.

These “Natural Partners” will be the “anchor” tenants” necessary to attract other partners, clients, and tenants to the development. These latter must be identified with special care to create a viable mix of enterprises that will both provide a healthy balance of diversified exports and meet a major portion of the physical needs of the growing community of people locating in the development to run and operate the various enterprises:

- Modular housing, other pressurized structures
- Furniture and furnishings
- Food
- Other basic products

Summary

This is a plan in which costs are identified and shared in a manner that makes the development

- Physically doable
- Financially viable
- Environmentally compatible
- Politically feasible

This is a prescription for a rational plan to share both equity and debt, to remediate any waste problems, and to share the costs of further improvements useful for all or most parties.

Reader comments and suggestions to further improve this general approach to lunar industrial development are welcome. Email: kokhmmm@aol.com <MMM>

MMM #134

Political Independence for Lunar or Planetary Settlements:

By Larry Friesen

In much of the discussion about political arrangements for lunar, planetary, or asteroid communities in MMM, and in a lot of other literature of space-interest groups as well, it almost seems that many writers assume that political independence of the Moon (or Mars, or a settled asteroid) is both inevitable and desirable. Not that any writers expect that to happen immediately, but most writers seem to expect it to happen eventually.

I would like to put forward the idea that political independence is not inevitable. It may happen. But I'd like to get out of people's minds the idea that it necessarily must happen. Neither would it necessarily be preferable to political membership in or alliance with a larger entity (federation, coalition, or what have you).

I believe that what you described in MMM as “home rule”. with the residents making decisions about local matters internal to their settlements is inevitable, or nearly so. While communication between Earth and the Moon or Mars or elsewhere in the solar system can be at the speed of light, the realities of travel time to the Moon or planets are likely to make trying to run local settlement affairs by “remote control” from Earth impractical.

I submit, however, that no one can predict how the political status of extraterrestrial settlements will evolve beyond the “home rule” stage. In particular, no one can predict whether the Moon or Mars or any other extraterrestrial body will become a fully independent nation-state ... or whether their inhabitants will even desire it. If and when that happens, it will happen in response to specific circumstances and events in a future history that has yet to unfold.

One thing that has influenced my recent thinking on this topic is a book I’ve been reading about the American Revolution by John R. Alden. The book was written in 1969, but I don’t think his ideas are at all out of date. Mr. Alden points out that at the end of the French and Indian War, no one on either side of the Atlantic was expecting that only a dozen years later, an American war for independence would be starting. In 1763, Americans were pleased and proud to be British subjects. It was only after a long series of British policies and actions that the American colonists perceived as provocations, that a substantial number of Americans felt pushed to make a separation.

As one example of such a provocation: Most American history courses and textbooks note that the British claimed that many of the taxes they were attempting to levy in America were to support British troops stationed in North America, supposedly for the colonists’ protection. Stated this way, the British argument sounds reasonable. What was not mentioned in the American history course I took in high school, but John Alden does mention, is that more British troops were stationed in North America on a permanent basis after the French and Indian War than before. This fact made many Americans suspicious of the reasons given by the British government for stationing the troops. They asked themselves: against whom are we needing so much protection? The French menace was gone; Britain now controlled Canada. The threat of Indian attack was no greater than before; it was probably less, since the French were no longer provoking tribes that had been allied with them to hostility. So why do the British need more troops than before the war, when there was a real threat? The Americans further asked themselves: With no more threat from the French, is the real reason for all those troops to begin establishing a tyrannical regime?

Whether or not that suspicion of British intentions was correct, it is an example of the suspicions and provocations that accumulated slowly, piece by piece, one by one over time. Although twelve or thirteen years is short on a historical scale, it was not a sudden process for those who lived it, and for many of the individuals who ultimately advocated independence, the choice was an agonizing one.

At this point it may be useful to distinguish between two kinds of freedom: one is personal liberty; the other is political independence. Personal liberty means being allowed to live your own life, to make your own choices about most things, to choose your friends, your occupation, your religion, and so forth; to speak or write your opinions freely; to live under a government and court system which protects your rights. Political independence means having your own nation, without being subject to some other [outside] power. The Americans in their War of Independence were choosing the tool of political independence to achieve the goal of personal liberty.

The two don’t always go together. Most Americans in the 1760’s and early 1770’s would have been perfectly happy if the British government had changed its course and respected their “rights as Englishmen”. Mr. Alden points out that had the British government made a few fairly minor changes in policy at certain points, or had different groups of politicians succeeded in taking power in parliament at certain times which would have resulted in policy changes), the Americans might well have been satisfied, and a separation from Britain might never have taken place.

On the other hand, most of us can cite numerous examples in the 20th century where many nations in Africa or Southeast Asia achieved political independence but became rather nasty dictatorships. People living in many of those nations, especially if they were not allied with the ruling political party, found themselves with many few civil liberties than they had enjoyed under the colonial powers that had formerly ruled those nations.

I propose that the kind of freedom that should always be our goal is personal liberty. Sometimes, in some situations in history, that goal is best served by political independence, as it was for Americans in 1776. At other times, in other historical situations, that goal may be better served by political union. For example, once Americans achieved independence from Great Britain, they concluded they could better keep their new-won freedom by facing the world as a federal union, than as thirteen separate nations.

In the same way, whether the personal liberties of people living on the Moon or Mars or anywhere else will be better served by political independence or by political union with other powers will depend on circumstances. Circumstances which cannot now be predicted, and circumstances which may change over time. <LF>

An Ardent Rebuttal

By Peter Kokh

When a child grows up, it is very often some specific concrete circumstance or event that triggers the decision to leave home. But in most cases, if it is not one thing, it will be another. If it is not now, it will be later. Independence is part of growing up. At first there may be some rebellion involved, some trying to distance oneself from home, parents, roots -- some trying to establish one's own sense of identity. This accomplished, in most cases, there is a happy rapprochement between offspring and parents, and a new appreciation on both sides for the other. And lo and behold, dependence is succeeded by mutual cooperation or interdependence.

We should hardly expect it to be otherwise with communities. Mr. Friesen makes the distinction between individual liberties and independence. This is not quite complete. Because communities have individual liberties as well. A settlement, every bit as much as an individual person, will value, in Friesen's own words, "being allowed to live your own life, to make your own choices about most things, to choose your friends (nations to collaborate with and trade with), your occupation (read industries and economic diversification plans). An Earth nation can never have the interests of an off-world dependency at the top of its list of concerns.

Domestic matters will always take precedent to the detriment of full support of settlement growth and industrial diversification and other needs. By withholding support for an expansion initiative sought by the settlement, the parent nation maintains a stranglehold upon it. This may not be deliberate, of course. It is simply a matter of other priorities. A settlement should then be free to seek support elsewhere. How can it do this if there is no "personal communal liberty" to make such approaches?

In the end, what happens will depend on the growth both in population and economic diversification and self-manufacturing of the off-world settlements. If there are never more than a few hundred people on the Moon or Mars, the question becomes moot. There will be too much economic dependence for political independence to be a viable venture.

To lump the Moon, a 3 day trip from Earth virtually anytime, and Mars, a trip of many months possible only every two years, in the same basket when discussing possibilities and eventualities seems naive. It is possible to "do the Moon" at the end of an umbilical "cord". It is not possible to "do Mars" in that fashion. Independence or not, the Moon's effective collaboration and interdependence with Earth will always be much greater.

But I would agree, that settlements will have a much greater chance at economic viability and hence at effective equality with Earth, the more they work on their own interdependence. United they will stand, divided they will fall. If they let fears of "one worldism" stop them from

collaborating, they will not have a chance. Neither in the end, will we on Earth. Independence, is, in last analysis a fiction. We are all interdependent and best glory in it. <PK>

MMM #170

Harbor & Town



By Peter Kokh

Anyone who has read science fiction stories about the Moon or Mars has come across names like Port Roris, Port Heinlein, Port Lowell, Marsport, etcetera. It seems a natural way to name a space frontier town. Indeed, won't every such burg be a port? Not really! In the first "beachhead phase" of settlement, we are likely to use vehicles like the Apollo era Lunar Excursion Module that could self-land, self-unload, and self-launch – no (space)port facilities needed, thank you!

But this sort of clean operation, efficient and necessary in opening virgin territory, also limits operations. Sooner or later the outpost/settlement-to-be will initiate genuine port functions. There'll be repair shops, fuel depots, landing beacons and paved pads, even smoothways for craft touching down with a residual horizontal velocity. There will be mobile cranes and specialized gantries. Trouble-shooters will service engines and doctor ailing CELSS air and water recycling systems. And a genuine space port will have been born.

To avoid expensive duplication, other outposts and towns that can be provisioned overland or by suborbital hoppers may choose not to develop full port facilities. They will have their self-service landing pads and smoothways, of course and they may see the occasional self-unloading freighter or chartered tourist craft, but nothing like the frequent, even scheduled cargo and passenger service of the "central" or "regional" spaceport. And this difference will translate into settlement lifestyles and cultures that are radically distinctive.

In contrast, one almost never hears the word "port" as part of the name of some fictional space settlement or O'Neill colony. Perhaps that is because the word naturally connotes to us the existence of some corresponding "hinterland" which the port serves. And our vision of space oases has been that each is a self-sufficient island unto itself.

How realistic is that? While each space settlement must have docking facilities, sooner or later one will offer special "port facilities" that will attract more traffic, making it a hub from which others are served by secondary craft. Indeed it seems to us more logical that one major spaceport or yard will emerge in the L5 co-orbital field, another at L4, and that a growing percentage of traffic will converge at these facilities, with cargo and passengers increasingly transshipped by barge and shuttle to "hinterspace" settlements.

If full service spaceports emerge on the frontier, what will they offer? In addition to the facilities and services already mentioned, port city contractors will overhaul, rebuild, re-outfit, and reconfigure aging spacecraft and their systems. There will be a "junkyard" or salvage dealer, maybe even a graveyard for obsolete craft (a museum in the making!) There will be warehousing for incoming and outgoing backlog buffers of cargo. There will be tank farms for liquid and gaseous volatile storage and chemical feedstocks. There will be a fuel depot for the many kinds of fuel likely to be used: liquid Hydrogen and Oxygen, Methane and Ammonia and Silane. There will be hoppers of powdered fuel: Iron and Aluminum and their enhanced performance powdered alloys. There will be containerized unloading and transshipment facilities.

In the nearby town will be the ship chandlers: dealers in ship supplies and equipment. Exporters of heavy equipment will find an advantage in a port city manufacturing site. The bigger transshipment firms will headquarter here. Chemical, engineering, biospherics and electronics laboratories will sprout up to serve the growing list of port service contractors.

But the port town will also see the rise of import-export banks and trading houses, of "marine" insurance firms and trade law lawyers. Stock markets and futures markets could arise. Wholesalers will cater to the distribution market, fostering hinterland growth and that of the port city with it.

Port cities may vie to become the "homeports" of various ships and whole merchant fleets. A sort of "Hanseatic League" of the major port cities in the Inner Solar System might arise to promote free trade, and regulations in their common interest, perhaps even footing the bill for a policing agency to counter piracy and hijacking. Such an alliance could be a forerunner of a loose System-wide political federation.

Port cities will tend to be socially and legally rather liberal in their mores, and noticeably more cosmopolitan in their ethnic and cultural diversity. In contrast, town founders wishing to try some great social experiment are likely to pick settlement sites off the beaten trade track.

Goods, both import and export, will be transshipped to and from the regional spaceport and hinterland or hinter space communities. Much of this traffic will be containerized, using space barges, overland truck trains, and suborbital hoppers or slide landers, as the case may warrant. Passengers will travel to and from the spaceport city by feeder surface coaches and suborbital craft or space-to-space shuttle taxis. Material novelties and cultural innovation will ripple outward from the space port centers to dependent outlying settlements.

Detachable holds of speculative trade vessels making circuit rounds between various settlements might be designed "snugline" fashion to slip into special airlocks and taxied or tugged to an in-city market berth where they could unfold for business, self-contained import shops ready-to-go. Resident hawking agents would vie for the business of visiting trader ships not so equipped to do their own marketing. These trader craft or "circuiters" would work to increase the amount of trade, thereby helping diversify the art-craft and manufacturing base of each city on their routes. As a result, an ever greater percentage of frontier settlement economies would be involved with mutual trade as opposed to trade with the home planet. And an ever greater portion of that trade might be speculative rather than based on direct customer order.

This trade will be in specialty foods and delicacies, in special fibers and designer apparel, in chemical and organic feedstocks, in strategic raw materials and locally deficient volatiles, in furnishings and arts and craft accessories and gifts. An emporium, for the latest usually unavailable goods hot off the "traders", may determine by lottery who'll have a privilege to purchase items too few to match the demand. There will be barter and haggling. Dealers and galleries will take some speculatively imported art and craft items on consignment. Recognizable spacecraft parts may become fad "canvas" pieces for port artisans, much as old saws for country painters.

There may be trade in salvaged ship decor pieces and "architecturals" in demand by restaurants and hotels to provide space-maritime "atmosphere", or sought by individuals for their dens. Decommissioned spacecraft could find themselves resurrected as visitor centers, nightclubs, and roadside motels.

And what about visiting spacecraft personnel, the spacers and spacehands of lore? The port city might offer more spacious and comfortable quarters in which to enjoy their liberty or "shore leave". There will be catering chapels and counselors, recreation clubs and sports facilities, and fast track intensive schooling. There will be medical clinics to treat postponed problems, and specially scheduled seminars to help them catch up on the latest technology in their field. The port will also be a place to receive waiting non-electronic mail.

Married spacehands may keep their families in the port city, their children in its schools. The Moon and space settlements offering lunar standard 1/6th gravity will be the favored

homeports for spacefarers, for the adjustment to and from zero-gravity will be much easier. Spacecraft providing artificial gravity are far likelier to offer the lower lunar standard as it is much less structurally taxing, and means either slower rates of rotation, a shorter radius or both. Few space-farers will call Earth home, or even Mars. "Sixthweight" rules! For the same reason, spacer guilds and guild halls are likely to be quartered in sixthweight ports. Here too will be the favored communal resting places for spacehands who do not prefer consignment of their remains to the so lonely depths of space.

And for the legally or behaviorally footloose there will be the usual spacefront dives and flophouses and dance halls: places where they can get quick fixes of whatever they found themselves lacking on the long journeys between ports. And there'll be unscrupulous town merchants seeking to trade worthless baubles for shore wages. Tattoo parlors? why not! But also prisons and brigs where needed.

Which brings us to the subject of salutary outlets for people who don't find themselves fitting in. The port xity will be a place for tired spacefolk to settle down. And the roster vacancies aboard visiting craft will be a siren for the town's restless. The port town's young will be drawn to the spaceport to watch the incoming and outgoing traffic, feeding their wanderlust. It is from their ranks preferentially, as opposed to the young of hinterland and hinterspace frontier towns and out-posts, that the next wave of volunteer settlers will come when some new world or worldlet is about to be opened.

Yet this dose of reality for would-be surface ports on the Moon and Mars! Increasingly, larger spacecraft, including all those using fixed booms rather than winchable tethers to provide artificial gravity in cruise mode, will be forever confined to space, unable to make planetfall.

Only zero-G space craft and shuttles will come down to the surface, plus the unique class of smaller circuit-making trader ships that are designed to separate in space into winch-tethered components for spin-up to sixthweight mode. [See the description of the aerobrake Earth-Moon ferry "Jules Verne" in "Lunar Over-flight TOURS" in MMM # 21, Dec '88, MMM Classics #3.]

If this is so, then THE lunar spaceport may be a space depot in low-lunar-orbit, "LLO". Here the large fixed-configuration cargo and passenger ships will dock, their wares taken down or brought up by "lighters", passengers by shuttle taxis. Here in the environs of "Port Lunagate" will be the big ship-yards for big craft and their even larger successors. But, if this is only a transfer hub and not a population center, as seems the likelier eventuality (to this incorrigible planetary chauvinist) then the surface port xities that it serves will still hoard the bulk of the port-typical features discussed above.

Still, even if the really big ships never swoop down out of the starry lunar skies, the comings and goings of smaller craft will be the talk of the town. Reporters will interview inveterate old spacers, thirsty for the latest yarns. Newspapers will advertise the sudden manna of trader-brought goods. Restaurants will advertise the sudden availability of rare delicacies and savory delights. The port's bars will be enlivened by the company of the visiting spacefarers. Art and literature in the town will mirror this opening to the larger world. And among all the settlements on the frontier, those that are port xities will be the liveliest, most colorful, most memorable.

Yet for every Yin there must be a Yang. There will always be those who prefer the quieter, more relaxed, less quick-changing "best kept secrets" of hinterland and hinter-space towns in which to live, and raise their families. **MMM**

National Parks on the Moon

By Peter Kokh

World Book: [a] **National park** is an area set aside by a nation's government to protect natural beauty, wildlife, or ... places of cultural, historical, or scientific interest. ... Governments create national parks to guard their natural treasures from the harmful effects of farming, hunting, logging, mining, and other economic development.

The world's first national park, Yellowstone National Park, was established in the United States in 1872. National parks gradually spread throughout the world. Today, about 1,500 national parks ... [exist] in more than 120 countries.

The Moon is “virgin territory,” -- well, almost. Intact artifacts left behind by the Apollo manned Moon landings and various robotic missions are destined either to be part of future Frontier Republic historic National Monuments or to be relocated in Lunar museums.

Now is clearly the time to think and act ahead about preserving and protecting some areas of the Moon of especial geological interest or scenic beauty by setting them aside as, for now, International National Parks (to be transferred to the Lunar Frontier Republic as the latter emerges as a de facto civil authority).

There are at least two steps here. The first is the creation by international treaty, provisional classes of lunar “national parks,” and a set of “protocols” which would protect them from economic and industrial development, allowing or disallowing road development and commercial “concessions.” Of course, once jurisdiction passes to the local frontier authority (a stepped process which should be milestone-driven and established beforehand by treaty to remove it as a political and power-play issue,) that authority would have the right, limited and defined in its own constitution, to review and reset any such protocols.

The second step is the nomination by an international committee of self-selected geologists and other scientists, tourist industry panels, commerce and industry representatives, and interested individuals of specific features or regions to be so protected. This list, to be an “attachment” to the original treaty establishing a Lunar National Park System, could always be added to later on.

For both of these steps, there will be considerable disagreement. Some will want to guarantee the treasured sites on the originally list from any and all human encroachment, while others will seek more pragmatic provisions. A reasonable compromise would be to create classes: class A containing the most protected, class C those only minimally protected. Some will favor only a few original parks, others will want to preserve half the Moon or more. There will be wide differences of opinion on the merits of individual areas to be selected for the original list. But it should be possible to find broad agreement on a starter list, and compromise positions on the protocols governing them.

Mining & Processing Industry Protocols

We have previously pointed out that “Moon mining” is not likely to be an especially “scarring” operation. The elements we need are to be found in the already “pre-mined” impact-pulverized debris blanket of rock and powder, meters-thick, that covers the entire lunar surface: the “regolith.” That said, we can split mining operations into those seeking to “produce” elements found just about everywhere or, at least rather widely [oxygen, silicon, iron, aluminum, calcium, titanium, magnesium – all in parts per hundred; others found in parts per ten thousand] and those concentrated only in a few atypical areas. Clearly, any mining activity seeking elements in this first classification, since it can be done most anywhere, can be completely forbidden within the selected park areas and their approaches.

Any rare and strategically needed elements which are especially concentrated in an area nominated for inclusion in the Lunar National Park System, could be mined within the area in question, in a tightly regulated “clean” operation, and then processed elsewhere. What we have in mind is the possibility that we would discover that a protected impact crater area is of the Sudbury (Ontario) type, rich in asteroid-endowed metals otherwise absent on the Moon in economically producible abundances, such as copper, zinc, gold, silver, platinum – all

industrially strategic. Lunar geologists have yet to identify any such “heaven-blest” area, it is possible one or more may be identified in the future.

Tourist Industry Protocols

Some areas, chosen for inclusion on the original list for their especial noteworthy geological features, might also be identified as having especial scenic value. Others areas of no unique geological interest, may be nominated for inclusion on the merits of outstanding scenic appeal alone. In either case, if we are not to be left to “tour” them at the end of an Earth-bound telescope or from the porthole of a passing spaceship, we need to consider public access.

Access can be restricted to guided “Eco-tours” aboard “self-contained” excursion coaches, or opened up to do-it-yourself self-guiding tours for individuals in private vehicles. The limited access provisions would apply to especially fragile sites and may include “pack it in, pack it out” regulations to guarantee that human detritus would not accumulate. An option, once traffic merits, would be excursions via suspended monorails or cableways, hugging the high ground where possible.

Once tourist traffic and volume grew to the point where it made sense, could allow and provide for carefully regulated tourist-serving “concessions” within the park area – hotels, restaurants, “general stores,” even RV camping grounds. If these operations could be conveniently placed at, or just outside, the park boundaries, that would be preferable.

Transport Corridor Protocols

Roads and trails are an important item to discuss. In some especially delicate areas, we may want to allow only a bare minimum of overland access, keeping the route as “rustic” as possible. For especially scenic craters, rilles, escarpments and other high vantage points, we may want to provide only scenic “rim roads” or scenic overlooks, with no access to the floor or area below other than by specially equipped go-anywhere, off-road vehicles that do not require intrusively bulldozer-graded routes. In a few cases, the Alpine Valley providing access between northern Mare Imbrium and Mare Frigoris for example, we will want to provide for a major highway, a minimum of traveler-serving concessions, and tightly regulated signage.

The merit of transportation access is obvious. How else are we to enjoy these treasures set aside for us? By browsing through a book or watching a DVD documentary? We could provide both, of course, for tourist wannabes and those selecting their itineraries. But for the future Lunans themselves, if not for Earthworms like ourselves, access is clearly in order -- access with thoughtful restrictions.

Some Park-worthy nominations

There are noteworthy areas, features of special scenic interest -- at least from our wrong-end-of-a-tele-scope vantage point -- in all areas of the Moon’s surface: in the nearside highlands and maria; on the farside. As we do not know (although many are prematurely “sure”) where the first outpost will be sited, and where early and subsequent industrial settlements will spring up, it will be important to identify candidate sites all around the globe for protection. With my 12” globe of the Moon in hand, I’d like to start the list off with the following short starter-list nominations:

- nearside craters: Aristarchus, Plato, Copernicus, Tycho, Theophilus, Proclus – there are equally outstanding craters elsewhere on nearside, that could be added to the list if settlement, transportation, or mining activities were to be considered nearby.
- other nearside features: the Alpine Valley, Hadley Rille, the “interruptions” or “bridges” along Hyginus Rille, the Straight Wall, the Altai Scarp, the Rheita Valley
- nearside historical sites: the Apollo Moon landing sites, the Lunakhod sites, any intact landers.
- Farside Craters: Tsiolkovsky is at the top of my list, Van de Graaf

Once the site of the initial international outpost is agreed open, worthy sites within reach should be identified and protected appropriately. One may argue, of course, that most places on the Moon are already protected by their very remoteness and inaccessibility. But the

day may come, when many noteworthy places will no longer be remote and inaccessible. Establishing a Lunar National Park System infrastructure, even without a short list of first inclusions, would be a wise move for these reasons:

- It is easier to establish such a system now, when the threat seems remote, than later, when economic counter-interests may have arisen.
- Early establishment of a Lunar National Park System will be a media coup, thrusting the Moon and its beauty into the public consciousness.
- It will whet the appetite for lunar tourism, thus helping create the justification for development of the vehicles and systems needed for on-location tours.

Extreme Touring

As on Earth, some parks will get the majority of tourist visitors, being “on” the most popular itineraries. But also as on Earth, there will be a tourist market for those who wish to explore “off the beaten path” in remote or usually overlooked areas or in “virgin” territory.

First Robotic Tele-tours

The very act of establishment of a Lunar National Park System by treaty, along with a starter list of included areas, will lay the economic grounds for private enterprise to land robotic “tour guides” on location, to photograph and explore the especially scenic features with maximum “ooh and aah” appeal, to be included in edited tourist documentaries on video and DVD or in **National Geographic**, along with promotions of the sponsor tourist companies, of course. Tourism “pump-primers.” A next step would be actual live tours, rehearsed or unrehearsed, exploring especially mysterious areas such as the first lavatube to be entered.

Flora & Fauna Preserves

When we think of “National Parks,” places of great geological and biological beauty come to mind: Yellowstone, Banff, Great Smokies, etc. Yet we too have preserved areas in which life is sparse, if not all but invisible: the Grand Canyon, Arches, Haleakala, for example. Biological preserves would seem to be out of consideration on the barren and lifeless Moon. But someday, that may not be the case.

In pressurized urban areas, we may set aside and designate as “wilds” areas left to be seeded at random by the birds, insects, squirrels, and ventilator winds, as an experiment and educational project spanning generations. We might also set aside areas to be landscaped and planted with trees and plants and wildlife of no economic importance at all, just for settler enjoyment and appreciation of beauty, and as places for peaceful retreat.

On a larger scale, heavily-traveled inter-settlement routes between neighboring population clusters may one day be relocated into pressurized tubes or rilles with broad fringe areas that can be planted with a mix of crops and purely ornamental plants -- parkways. And there may be small scale “national forests” created in pressurized structures by private enterprise seeking tourist dollars.

A Lunar National Park System will have a profound impact of the way lunar settlement develops, and even on its pace. The time is ripe. Let’s get started! <MMM>

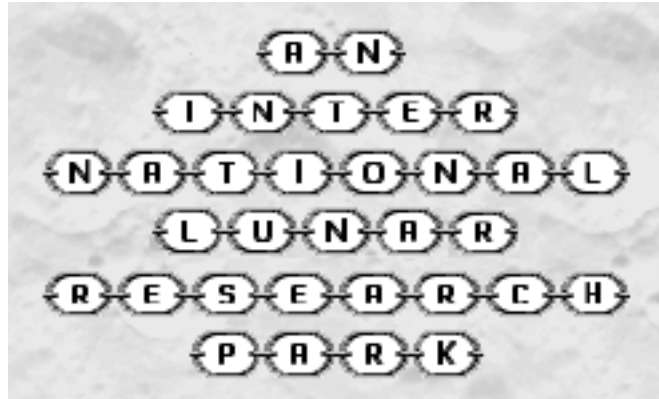

An International Lunar Research Park An Open-ended Lunar Initiative

By Peter Kokh and David Dietzler

Current Prospects

The United States, under former President George W. Bush, redirected its ISS and Planetary Exploration-focused Space Program to a “return to the Moon” and “beyond to Mars.” This direction will probably continue under President Barack Obama. Meanwhile, China, India, and Japan have launched lunar probes and spoken of putting crews on the Moon. Whether these will be one time “science picnics” à la Apollo or real efforts to establish permanent facilities to support manned exploration sorties and other activities remain to be seen.

The Question

If each nation picks a different location on the Moon for its surface activities, areas of cooperation are limited to data sharing, tracking, and other support activities.

If, however, some or all national lunar outpost efforts are concentrated at one and the same location, be it at the North or South lunar poles or somewhere else, then the opportunities for shared facilities is enormously increased, and with it could come major savings by reducing unnecessary duplications.

Shared Facilities: Corporate Partners

Of course, then the question becomes “who will build and provide the facilities to be shared? And right here we have the opportunity to introduce new parties: contractor companies. Possible contractors could include Boeing, Lockheed-Martin, EADS, Antrim, and other names associated with the Aerospace industry, but also other major contractors. To pick a few: Bechtel, Halliburton, Mitsubishi, and on and on.

Additional Players: Enterprise, University Consortia

If we collectively choose to establish not a collection of national outposts, collocated or not, but an “International Lunar Research Park” the possibilities for future expansion, elaboration, and outgrowth – even into the first human lunar settlement – will increase enormously.

Facility Lists

The lists below are meant to show how great are the possibilities for diversification and outgrowth. The items in **bold** will come first. Plain type next, italics last. Note, that this subclassification is just one person’s first attempt, and corrective input is most welcome. No one expects to “get it right” the first time! What we want to do is to put out the general concept of how enormously the choice of an Inter-national Lunar Research Park could bust the future wide open. After the itemized lists (we surely have forgotten or not thought of many items!) we will give our thoughts on just what must come first.

National Outpost “core” elements

- **Base habitat**
- **Base laboratories**
- **Basic life support**
- **Command center**
- **Airlock**
- (Power generation)
- (Power storage)
- (Warehousing)
- (Landing/launch pad)

The items in parentheses are things that in our judgement could be contractor-supplied.

Contractor Corporations

- **Site preparation**
- **Spaceport services**
- **Construction equipment**
- **Shielding services**
- **Fuel storage**
- **Fuel production**
- **Power production**
- **Power storage**
- **Warehousing systems**
- **Thermal management**
- IRU Research
- ISRU Manufacturing
- Habitat expansion modules
- Biospheric maintenance
- Road construction
- Connectors
- Gas scavenging

Enterprise Opportunities

- **Commons with meeting space**
- **Restaurant(s), pub(s)**
- **Recreational facilities:** exercise, sports, dance, theater
- **TV/Radio Facilities**
- Instruction<<<
- **Financial services**
- **Hotel facilities** for visitors, tourists, overflow between crew changes
- **Cabotage** (outfitting) services
- **Vehicle maintenance**
- **Space suit services**
- **Tools, equipment**
- Tour coaches & excursion services
- Marketplace
- Green (horticultural) services
- Waste treatment

- Recycling services
- Reassignment services (new roles for scavenged parts of landers etc.)
- Agricultural production
- Customization services
- Event management
- Surface recreation vehicles
- Archiving services

University Consortia

- **Medical Center**
- Continuing education
- Research facilities
- Astronomy installations

Joint Civic

- **Road planning local**
- **Road planning regional**
- **Environment protection**
- **Environment enhancement**
- (Parkways, gardens)
- Outstation planning

Discussion – where you come in!

It would be miraculous if the list above did not have many holes, even if nothing was misclassified. Your input is most welcome!

The effort above is an attempt to start a discussion and to keep us, nationals of the various countries contemplating lunar surface activities, from being blind-sighted to the enormous advantages to be gained not only by collaboration between the various national agencies, but by restraining agency hybris and taking the plunge to invite corporate, enterprise, and university consortia as equal partners in a joint “human” effort.

The idea is for the national outpost agencies to buy or lease or tent equipment and services from the contractors and enterprises as their needs change and expand. This should provide not only substantial cost savings but a greater variety and supply of equipment and services.

Agencies need not provide quality and other specifications, because corporate and enterprise personnel would be just as much at risk from improperly designed and manufactured equipment as would national agency crews. Toss out the mind-boggling bureaucratic paperwork, and down comes the costs.

Corporation employees would need housing, and all the other life support services as needed by the agency crews so it is natural, that as they begin to construct pressurized modules and other equipment from lunar building materials that they could provide for expansion of national outposts as well at considerable savings.

The national outposts would be “anchor tenants” so to speak, but as in shopping malls, in time their share of the economic value of total activities and facilities at the site might become, even though essential.

Some sort of Civic Council representing all of these Parties would be needed to make decisions that affect every-one, decisions about growth directions, environmental safe-guards, and so on. As this unfolds, the International Lunar Research Park will have become the first lunar settlement!

It is time for humanity to open the next continent, one across a different kind of sea. The “out of Africa” effort is ready for the next act. Only humans as a species, not horse-

blinded agency managers, have the vision to grasp what is needed – and it is not a collection of agency outposts!

What Comes First?

Frankly, national agency planning puts the cart before the horse. Why? because two things come first, and no one is giving either one more than trivial attention.

Part I: Technologies for using lunar resources

We are not going to anything of lasting significance on the Moon unless we learn how to process useful building materials out of the elements in moondust. Known by the uppity Latin term “In Situ” Resource Utilization (“on location” works just fine!) various processes have been proposed to isolate oxygen and other elements, but few have been tested either in laboratory scale or (more importantly) in mass production scale. How do we advance the “readiness” state” of these technologies? It is important to have them ready to go when we land on the Moon. Getting there, and then having to scratch our heads for additional time-wasting decades makes no sense. But that is the path we are on.

This topic will be the subject of the next article, “Improving the Moon Starts on Earth” – reprinted from MMM #s 132,133, February and March 2000.

Part 2 – Site Development

No site on the Moon, no matter what advantages are touted on its behalf, is anything more than “unimproved” land, what in America might be called “Florida swampland.”

Before the first national agency manned lander sets down on a chosen site, it makes sense for a corporate contractor to have already “improved the site” – conferring on it various advantages that will make outpost deployment, construction, and operation so much easier. Indeed, Carnegie–Mellon University, a contestant for the Google Lunar X–Prize, has just proposed that establishment of the first spaceport be contracted to the university to be done by telerobotics. www.post-gazette.com/pg/09063/952880-115

[We have seen many a proposal of how to jump-start a frontier with land grants and land sales. Maybe I don't understand them. To me, they seem like so many pyramid schemes based on nothing. Yes, the Moon is more than nothing. The ingredients for "stone soup" are all there. But it takes more than the right chemical elements in sufficient quantity to make a land valuable. They have to be present in a form we know how to mine and produce. And on the Moon that is not the case. The land has theoretical value only. What can we do with it when the tools to do anything do not exist?]

MMM #249

**Lunar Materials to Grow Earth EconomyThe Moon:
What's in it for Earth?
Part II:**

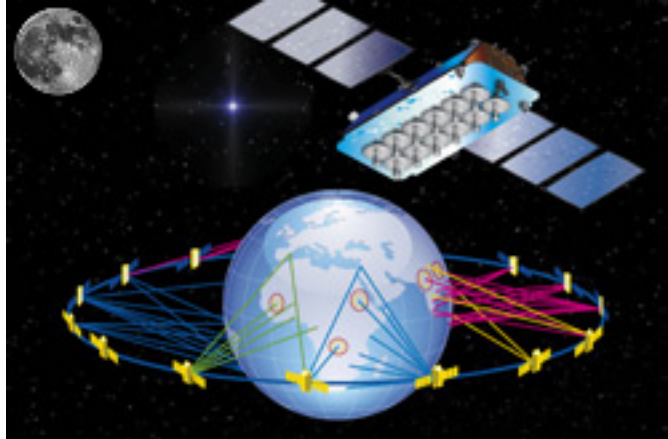

(Photo Credit: Briot/Thales Alenia Space), Moon image added
By Peter Kokh

How the Dream began

In the early 1970s, Princeton physicist Dr. Gerard K. O'Neill publicized a scenario in which we would go to the Moon, mine lunar materials near the equator and sling them into space with an electromagnetic "mass driver." There they would be used to build space settlements to house workers in comfortable and pleasant surroundings, workers who would use more lunar materials to build hundreds or thousands of gigantic solar power satellites to feed our planet's ever more voracious appetite for energy. Thus began the L5 Society. "L5 by '95" was a battle cry.

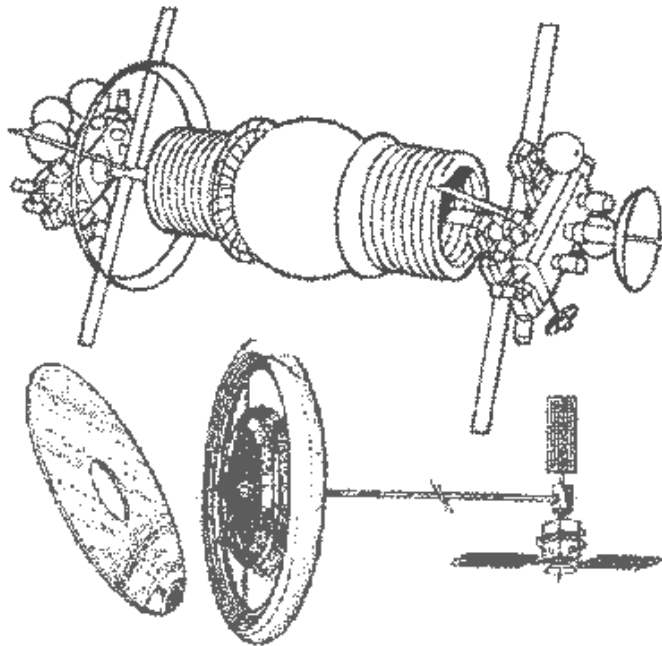

Bernal Sphere (Island 1) and **Stanford Torus** (Island 2, above

In response to Congressional requests, NASA even produced a comprehensive "Space Resources and Space Settlement" report in 1977 on the scenario and related ideas for Congress. It is still worth reading and belongs in every space enthusiast's library.

While the scheme was logical, too many of the needed technologies were still in the conceptual stage. To their credit, O'Neill's Princeton team produced successively three working model mass-drivers, each progressively more powerful and convincing.

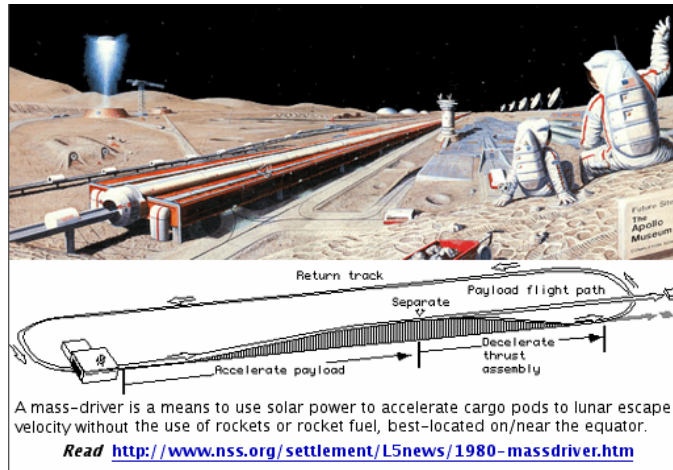

The logic of using “lunar materials” to build giant structures in Geosynchronous Orbit is impeccable: it would take only 1/23rd the fuel to “downport” (down the Earth’s gravity well) material’s from the Moon on the gravity well’s shoulder down to Geo-synchronous Earth Orbit as it would to “upport” them up that steep slope the much shorter distance from Earth’s surface. And this, goes the logic, would make solar power sats much less prohibitively expensive.

It is the unique economic potential of Geosynchronous Orbit (Economic Gross Product as of 2010 c. \$275 Billion) that makes the existence of potential construction materials on the shoulder of Earth’s Gravity Well so significant. The Moon and GEO are a natural team literally “made in heaven.” This is a 2-way economic case of “Location, Location, Location.”

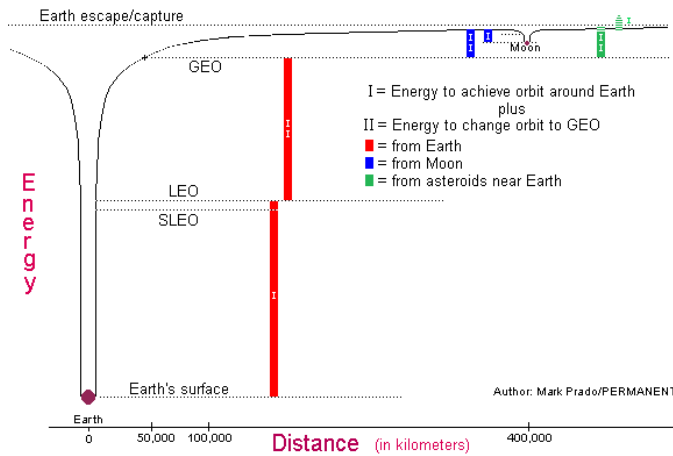

<http://www.permanent.com/images/t-gravity-wells.gif>

Enter The Giggle factor

Many of those old “L5ers” are still around, including this writer. But others, also convinced that Earth’s future depends on Solar Power Satellites, but not spiritual descendants of O’Neill, are reluctant to back plans that call for lunar sourcing of materials. It will take too much of an effort, gobbling up too many years of lead time, to industrialize the Moon to the point where lunar raw materials could make a significant and timely difference. And on the NSS Space Solar Power Committee, this division between O’Neillian believers and those never caught up in the L5 Space Settlement dream is quite obvious, with both sides talking past each other. Long overdue critical distinctions

1. Distinction between parts made on the Moon and those made here on Earth – this part of the puzzle’s solution is something I contributed way back in MMM #19, September 1988, pp. 3–4, “A Strategy for Following up Lunar Soil Processing with Lunar “M.U.S./c.l.e.” – In this plan, we would seek to produce on the Moon everything needed there that was Massive,

Unitary (we need many of the same), and Simple. We would produce on Earth for up-shipment, things that are complex, lightweight, and electronic. Now there are sure to be many things that do not fall neatly into one of these two divisions. But if they can be divided into “MUS” and “cle” subassemblies, then we have the problem of sourcing solved neatly. : Basic simple lunar industries will produce the lion’s share of what is needed weight-wise while terrestrial industries will provide the rest. This article is online at:

http://www.moonsociety.org/publications/mmm_papers/muscle_paper.htm

2. Lowering the expense of developing “in situ” lunar resources into usable building materials – this is a challenge we addressed even earlier, in MMM #16, June 1988, pp. 3–5, “Glass–Glass Composites” in we suggested that just the opposite of the “spin-off” process, “spin-up” would yield prototypes of tech–nologies needed on the Moon or elsewhere in space at much less research and development cost. Here, instead of a high–cost NASA crash program, entrepreneurs examine the list of needed technologies and examine each for possibly profitable terrestrial applications, then pre–develop those technologies precisely for those terrestrial uses. This article is also online at:
http://www.moonsociety.org/publications/mmm_papers/glass_composites_paper.htm
3. Pairing the use of lunar materials with the construction space habitats for workers – giant hollow structures with artificial gravity provided by rotation makes the combined concept a gargantuan one: attractive, yes, affordable maybe not. We must keep in mind the enormous progress made in robotics and teleoperated systems in the past forty years. We will need people on the Moon and in space, but perhaps at least an order of magnitude (factor of 10) if not two (factor of 100) fewer. That changes the economics already. Dave Dietzler brought this up recently in MMM #242, February 2011, pp. 7–8 “O’Neill’s High Frontier Revisited” – in short, many labor–intensive tasks in space will be performed by robot avatars, partly automated and partly teleoperated from elsewhere.
4. Building up the needed Lunar Industries – even given the above distinctions and novel approaches that greatly reduce the challenge of creating an industrial complex on the Moon capable of contri–buting the major fraction of the mass of Solar Power Satellite construction elements, the idea of lunar industrialization remains “science–fictional” to many. Well the Moon Society has addressed that as well, in our concept (Peter Kokh and Dave Dietzler) for an “International Lunar Research Park” – see MMM–India Quarterly [M3IQ] #2 February 2009 p. 20 and MMM pp. 5–6, #224 April 2009. The M3iQ article is online at:
http://www.moonsociety.org/india/mmm-india/m3india2_Winter09.pdf
The ILRP would be fully international, and thus quite resistant to any one nation’s budgetary pressures or waning of resolve, witness the International Space Station. The basic enabling parts (spaceport, warehouse, recycling operations, and more would be constructed by a contractor consortium, so that individual national space agencies could ship up their outpost modules and plug in, free to concentrate on the science and research they came to so. Other corporations and enterprises would be welcome. This is the kind of critter that could in time morph into the first industrial lunar settlement.
5. Identifying feasible lunar materials and how to produce them – This is a task to which Dave Dietzler and his “ILRP Team” has dedicated itself. What alloys of iron, aluminum, titanium, and magnesium, the four “engineering metals” are feasible on the Moon, given the low abundance of the usual alloy ingredients for each? So far, the team has identified several feasible options and how we can go about isolating the needed components from the mishmash of moondust in which minerals have not been concentrated into mine–worth lodes, absent the geological processes that work on Earth in the presence of water. If you have been a reader of MMM over the past few years, you will have seen much of Dave’s work.
6. Switching to more efficient, cheaper space transportation systems – We have written often over the years about the flawed philosophy of NASA space transportation architectures. First we need orbital refueling. Second we need to design all components for salvageability and reuse, all the way up the line from Earth orbit to lunar landing. The Apollo and Apollo on Steroids approach of Constellation and now its disguised reappearance as “SLS” are insane.

Getting into space has to be about getting into space, not providing money for the constituencies of key Senators and Representatives, or catering to the current stable of industrial–military complex providers. The Commercial Route alone holds hope.

But is anyone listening!

MMM’s circulation is worldwide but in very small numbers. We try to make our presence and work known at the annual International Space Development and other Conferences and have used our “University of Luna Awards” to persons doing research along the needed lines, to help call attention. It is an uphill struggle, but slowly, some of these concepts are being talked about. If we are not mentioned that does not matter as it is the ideas that are important.

There is more work to be done, especially in deciding trade–offs between what can be most cheaply made and shipped from whence to where. We are convinced that we are on the right track. PK/D

MMM #254



McMurdo Station is Antarctica’s “metropolis.” The US station shares a harbor (the world’s southernmost) and airfield and power grid with New Zealand’s Scott Station. International collaboration in Antarctica is a model to follow. McMurdo was established in 1956 and has grown by leaps and bounds, much of that growth unforeseen and inadequately planned.

The 2nd largest station is **Amundsen–Scott** at the South Pole. There will be some parallels on the Moon, but also many significant differences.

Antarctica as a model for International Moon and Mars Outposts

By Peter Kokh

In many ways, a hundred years of human experience in Antarctica can be seen as a prelude to human exploration of the Moon and worlds beyond. And the cooperative spirit that pervades human activities at the bottom of our world is a good recommendation for following suite on the Moon. We will more thoroughly explore the Moon together, than as rivals. And that collaboration will be most essential in learning how to make practical use of lunar resources: the number one goal of the proposed International Lunar Research Park.

In Antarctica, many national stations are isolated from one another, but not all, and it is those exceptions we are interested in. See this map: http://www.scar.org/information/Antarctica_stations_map.png

The hub of activity in the continent is the 56 year old US **McMurdo Station** (100+ buildings, summer pop. 1,200+). Built on the bare volcanic rock of Hut Point Peninsula on Ross Island, it is the farthest south solid ground that is accessible by ship. **McMurdo** has a close

neighbor just next door: New Zealand's **Scott Station**. They share an airport (Pegasus) and the power grid. **Scott Station** recently added three high power wind mills to create the southernmost wind farm in the world. The two stations undoubtedly share other resources and services, and they have been close partners in Antarctica from the start. The US supports McMurdo out of Christchurch, New Zealand.

<http://www.antarcticanz.govt.nz/image-galleries/category/12-windfarm>

Concordia Research Station, which opened in 2005, is a **research facility shared by France and Italy**, 3,233 m above sea level at a location called Dome C on the Antarctic Plateau. On the coast south of South Africa, in an ice-free rocky area known as the Schirmacher Oasis, the **Russian station Novalazrevskaya** and **India's Maitri station** are neighbors, sharing the Russian built airport. Elsewhere on the continent, there are several locations where different national stations are located close enough together to share resources and services, at least in emergency situations. This is especially true in the Antarctic Peninsula where many outposts are clustered.

Where possible and practical it makes sense to share infrastructure and services needed in common.

ShareSense: Logistics (airfield/spaceport); warehousing (fuel, supplies) Power grid and sources and power storage; construction equipment; hospital and other medical facilities; shared recreation and assembly space; final stage waste treatment facilities; tools and equipment used infrequently; unusual talent pool; "SuperPerk" facilities and retreats; manning joint expeditions. Such a plan and philosophy of sharing anything not needed by each full time makes economic sense.

If we can do this in Antarctica, why do so many space enthusiasts see our future in space of one of rivalries? In the light of our experience with the International Space Station and in Antarctica, that makes no sense. No country can afford to throw away money out of spite or rivalry. We are in Antarctica together. We can be on the Moon together! Ditto for Mars. Moreover, international facilities will more quickly lead to local autonomy and eventual home rule as international settlements grow. Nationalists, and there are still many in the US, are living in the past as a hundred years of collaboration in Antarctica demonstrates. Finally, international efforts are notably more resistant to government budget shrinkage or cancellation than purely national programs.

There are many things done in Antarctica which could be done much better: another story.



Above: the extensive dormitory residential buildings at McMurdo: Insulated but without visible protected pedestrian passageways between them. Built underground or at skywalk level, they would not interfere with surface vehicle access. This is the perfect place to demonstrate the merits of an interconnecting "**Middoors**" environment.

McMurdo could be a much nicer place, but most people are there on temporary tours of duty and have enough perks to endure. And this "oversight" is understandable as the station has grown well beyond the vision of its first planners in the mid 1950s. Growth has been haphazard and often without effective planning. McMurdo's history is lesson to be learned by planners of an International Lunar Research Park. Warehousing and storage of discarded items got very bad, but has been mitigated after a GreenPeace expedition called the "shameful mess" to the world's attention. Now the station is much more sensitive to its environment. **PK**

MMM #255

In Focus: Why Advocates of Moon and Mars Settlements should work to amend the Antarctic Treaty

“Failure to “responsibly modify” the current Antarctic Regime could very well result in a Treaty ban on “settlement” of the Moon and Mars, allowing scientist–explorers only.”

Antarctic Treaty Precedent – In 1959, Twelve nations, involved in Antarctic exploration, and with land claims frozen, established a treaty that would allow peaceful collaboration and coordination, signed the original Antarctic treaty. Since then 31 others nations who wish to conduct exploration and scientific research there have now “acceded” to the Treaty which was extended in 1989. It will next be open to review in another thirty years, that is in 2019. That gives us seven years to marshal support for some key changes.

The most significant of recent protocols was signed in Madrid in 1991 therefore being known as the Madrid Protocol, though it's official title is, “**The Protocol on Environmental Protection to the Antarctic Treaty**” which came into force in 1998. Most of the provisions are reasonable. But some of the provisions create a precedent that must be rejected if we are going to open the Lunar and Martian frontiers to resource–using settlement. Article 3 Environmental Principles is fine as it stands and is not the area of concern.

Article 7 states “Any activity relating to mineral resources, other than scientific research, shall be prohibited.” In our view, it would be better to rate specific areas of the continent according to environmental risk, and to set standards for mining practices such as to protect the environment. If all mining were bad, we would still be in the stone age.

Article 8 does make distinctions between activities with (a) less than a minor or transitory impact; (b) a minor or transitory impact; or (c) more than a minor or transitory impact. But the overall effect has been chilling.

We certainly do not object to a rigorous review of all mining and commercial activity proposals. But the outright “ban” is counterproductive. In effect, Antarctica is off–limits to settlement, if settlers are to produce any percentage of their needs, specifically, building materials.

Not helpful, the treaty applies to areas poleward of 60° south. If the Antarctic Circle had been the “fence,” about a third of the Antarctic coastlands (that portion south of Australia and the Indian Ocean) and much of the Antarctic Peninsula (below South America) would be excluded from this ban.

The principal base of McMurdo Sound and the very unique Dry Valleys lie south of New Zealand. These valleys are environmentally unique in all the world, but even there some scientific research – (these valleys offer the best Mars analog site conditions anywhere) – and even some commercial operations such as “photos and footprints only” tightly–guided tourism – should be allowed.

In our view, the Treaty notwithstanding, humanity has a right to settle and use the resources of both treaty–excluded and treaty–protected areas, under strict safeguards and protocols. The pro–space community sat on its hands when the Treaty was extended last time. We must rise to the challenge in 2019 and that will require a lot of careful and detailed preparation. We offer some suggestions in the article that follows.

1. **First, we consider what we might be able to do within the limits of the present language.**

2. **Then we show how some simple modifications would allow much more without undue harm** to this magnificent natural frontier.

Failure to “responsibly modify” the current Antarctic Regime could very well result in a Treaty ban on “settlement” of the Moon and Mars, allowing scientist-explorers only.
PK

Antarctica Activities can Blaze the trail for Pioneers on Moon and Mars

By Peter Kokh

It is essential that we demonstrate here on Earth, in Antarctica, that development and settlement can be pursued in a way that respects and preserves nature.

To do this, we need to set standards, something we have failed to do previously except retroactively, after damage done has become too significant to ignore. In that light, not to set standards in advance would be to disrespect the gift that is Antarctica, and that is the Moon, and that is Mars. Put it this way: to win a broader base of public support, we need to earn the respect and support of the “Environmentalism” community (to which, by the way, we personally are personally proud to belong.)

In his recent article “Are We Ready to Settle the Solar System?” [Moon Miners’ Manifesto India Quarterly 14 pp 27–33] Dave Dunlop writes:

“Pushing the Boundaries

Today there are many long term outposts on the continent of Antarctica, clearly the most challenging and “alien environments” on our home planet with the possible exception of the deep ocean. For the moment we have forbid ourselves the “luxury” of creating true settlements in this harsh terrain but have enduring outposts for scientific study and now increasingly tourism. The Antarctic enterprise shared by many nations is the best model of how we our aspire to poke our nose into new space environments. Our global Antarctic Program is The Grand Daddy of Space Settlement Initiatives but it is far from a sustainable settlement largely dependent on in situ resources.”

Potential Settlement Sites

There are a few science outposts “out on the ice” in Antarctica: Amundsen–Scott Station at the South Pole, Concordia Station (France–Italy), and Vostok (Russia) for example. The only local resources are ice and wind. Most other stations are on or near ice-free ground at various locations along the coast, or on coastal islands. But these stations have only one purpose: science. They are totally dependent on support from the sponsoring nation(s),

Even McMurdo which has over a thousand residents during the summer and is physically bigger than many a small country town elsewhere, cannot be considered a “settlement.” None of its residents is “permanent” – all are there on limited tours of duty – no families, no children. Official visitors only.

Raw Material Sources for Settlement and Settlement Basics

Most Antarctic outposts, McMurdo–Scott among them, are on exposed ice-free ground, where conceivably, some limited use of **local rock and rock debris (including basalt** from neighboring Mt. Erebus volcano) is a potential “resource” given enough experimentation and imagination. Adjacent seas are teeming with “food.” The ever-present steady winds blowing seaward off the Antarctic ice cap provide a significant energy-source. Coastal outposts may see occasional driftwood, beached animal carcasses, wood and steel shipwrecks, all sources of materials to creative and resourceful people.

That “mining” necessarily disfigures the landscape and poisons the environment is a blanket assertion and proposals to access materials for local use should be allowed to have a hearing before the Treaty nations in advance of the next scheduled review in 2041. Environmentalists stand to gain from such a process as

Ways to mine more responsibly and with less negative environmental impact, here in Antarctica, have the potential to transform for the better, how mining is done elsewhere on Earth. as well as to pretest means and methods of responsibly accessing resources on Moon and Mars

The idea of self-supporting settlements in Antarctica

Any true settlement has to provide for a wide variety of needs of its members. In short that means that

1. **What a settlement cannot produce locally, it must import from elsewhere, and to do that,**
2. **The settlement must produce products that it can trade for what it needs to import.** Some of that trade can be with other Antarctic Settlements, of course, but collectively, Antarctic settlements must export commodities to the outside world to pay for whatever they must collectively import from the outside.

Specific products

Together, this covers a lot: food, clothing, building materials (primary and secondary including furniture and furnishings); power, manufacturing equipment, vehicles; tools: the list is long, but can start small.

Currently, the only places in Antarctica that produce anything exportable are those that engage in fishing in the Antarctic ocean, which is, however, perhaps the most food-rich ocean of all. But most of this fishing is done out of ports in southernmost Chile and Argentina. Some amount of whaling has been supported out of small towns in South Georgia, which is hundreds of miles north of the Antarctic coast.

Beyond fishing: some options: wind power; rock products; minerals; fossil fuels

Wind: The Antarctic Coast enjoys the strongest steady winds on Earth, continually blowing coastward of the polar interior. Wind power is being used in Maitri (India's station) and at McMurdo-Scott (US, New Zealand). All that power is used locally. To be exported, wind power would have to be converted into some other power source or actually beamed elsewhere by orbital relay. So, at least near term, wind is a local resource, not an export option.

Nonetheless, this domestic source of power is definitely of significant value. **Most communities around the world are not as energy-independent as Antarctic Settlements could be.** Of course, this is electrical power, and fuels for non-electric vehicles and equipment must still be imported. But a greater reliance on batteries and fuel cells could increase wind-power applications to cover a growing percentage of non-electrical power needs.

Rock (and gravel): these are crude building materials, but in light of the fact that there are no trees in Antarctica, that assumes some real importance. The makings for cement would make this rock and gravel resource cover more construction needs: blocks, bricks, slabs, beams etc. are a great start. Basalt on the slopes of Mt. Erebus at McMurdo can be used as cast tiles, bricks, slabs, hewn and carved items, and as industrial fiber.

Other mineral resources: Metals, gems, etc.: We have no idea what lies under the ice, but the fact that at one time Antarctica was connected to South America, Africa and other "continents" that formed Gondwanaland, it should be expected that mineral resources in once contiguous areas should be similar. For example, what we find available in the southern Andes of Chile and Argentina, we should expect to find in the mountains of the Antarctic Peninsula. But for clearly practical reasons, we are looking at only exposed, ice-free locations. Except for the exposed nunataks of the TransAntarctic Mountain chain, that means **we are looking at ice-free coastal areas only.**

There are interior ice-free areas, the so called "Dry Valleys" across the Ross Sea from McMurdo Station, but these are so geologically and biologically so special that they deserve to be permanently protected as World Geological Nature Preserves, as they already are, with

limited escorted tourist excursions only, except for restricted science camps. There is no better place on Earth than here for a Mars Analog Station, but the logistics would be even more expensive. Off shore oil drilling should remain forbidden as there is no fool-proof way to prevent spills.

Fossil fuels: there is coal and oil in Antarctica, from the forests and vegetation this land once sprouted before it wandered south to the pole. Clearly, however, the most stringent environmental procedures would need to be in place to allow these resources to be tapped so that surrounding areas inhabited by wildlife of any kind are not polluted or spoiled in any way. If tapping these resources was limited to serving local needs, that might minimize potential damage, but at the same time, prevent settlements from trading these reserves for other needs.

A formula for responsible mining that we should strive for everywhere

Writing about how we should mine on the Moon, in MMM #22, February 1989, "Lessons from Mt. St. Helens" we pointed out that there is nothing that sparks the inventiveness and resourcefulness of artists and craftsmen and entrepreneurs in general as "free material" – in this case the inches of Mt. St Helens ash that covered large areas of the Pacific Northwest after the 1980 explosive eruption of this volcano.

Then, in the next issue, MMM #23, March 1989, our article "Tailings" addressed the issue that the bulk of what is mined is cast aside as "of no economic value" – tailings.

From the MMM Glossary <http://www.moonsociety.org/publications/m3glossary.html>

Tailings – what is left after the elements sought in a mining operation are removed. Actually, all other elements remaining are somewhat "enriched" in abundance by that removal. In a mining cascade, the tailings would continue to be further enriched in the elements not yet extracted. When it becomes impractical to mine tailings further, casting them into building materials would productively embody all the energy already spent, and minimize the amount returned to nature, the "throughput." The less the "throughput" of a operation or of an industrial settlement as a whole, the more efficient that operation or settlement can be said to be, and the more minimal its environmental impact or footprint.

Tailingbrick, tailingcrete – suggested building products to be produced from tailings.

You can read both articles, on page 11, and pages 17–19 respectively in Moon Miners Manifesto Classics, volume 3: a free download from: http://www.moonsociety.org/publications/mmm_classics/

Tailings-based Antarctic industries could help reduce the gross tonnage of imports from off-continent that will be required to support permanent settlements in Antarctica. And any tailings-based products used on the continent that are attractive enough to find a market elsewhere, will help pay for what must be imported.

It may take some time before Antarctic Settlements can reach and then exceed an economic "breakeven" point. But without the prospect of doing so, true settlement is unlikely. For supporters of Lunar and Martian settlement, the stakes in Antarctica are very high. We choose to ignore what is happening and can happen in Antarctica at our peril. Let's look at some other potential income sources

Other sources of income for Antarctic Settlements

1. **Tourism:** In 2010–11 34,000 tourists visited Antarctica and the numbers keep growing! While agency tourist guides take care of most of the tourist agenda, they should be required to enlist local civilian guides from any "settlements" they visit. There are currently only two such spots, and we'll get to them below. The idea, however, is to set a precedent. If in time at some of the various national science outposts, true permanent residents are allowed in support roles, this practice could be extended. Through such "subcontracting," a source of local income can be provided. Of course, we favor healthy competition, so at each location a choice of tour guide agencies would be ideal. We can see such an operation at an entry "gateway" to the Dry Valleys area for example. Tourists love souvenirs, of course, so such gateway civilian centers gift shops featuring crude unfinished souvenir rocks, as well

as locally produced art objects made from local materials would help. Tourism could thus employ tour guides, transport vehicle operators, translators, artists and craftsmen, and even entertainers. We have to start somewhere! Many a town in America (and elsewhere) thrives largely on tourism.

2. **Fishing:** Grytviken (photo below), on the North coast of the island of South Georgia is the outstanding example. However, this site is well north of the Antarctic coast itself, and for a reason: it is accessible and ice-free for a greater number of days than any site on the Continent, or on immediate off-shore islands. Yet some anchorage for fishing ships and fleets is available there, and with some front money could be developed.



So the resources necessary for a core of self-sufficiency to be complimented by imports is a difficult goal to reach. Beyond fishing and logistics support for tourist excursions and possibly for nearby science stations, there does not seem much upon which to establish genuine settlements.

The Obstacles and Challenges are Real but Must be Overcome

- **Antarctica poses a number of serious logistical problems to any would-be mining or prospecting activities;**
- **Antarctica experiences the most extreme cold on the planet. Mars' climactic range is very similar:**
- **Mutual isolation of outposts in Antarctica is a preview** of what it might be like on Moon and Mars. Such isolation is an impediment to internal trade. However, a clustering of inter-trading settlements on the Antarctic Peninsula and its off-shore islands provides an optimal place to start. On Moon and Mars both, some settlements will be very isolated, but for success, a critical collocation of neighboring settlements at some optimal locations will be critical to the development of lunar and/or Martian economies
- **The annual "icing-in" of Antarctica** imposes "no shipping" intervals, at least by sea, if not also by air. This "on your own" test will apply even more strictly on Mars as well, with launch/landing windows more than two years apart. If we can't succeed in Antarctica, it would be foolish to think we could succeed on Mars.
- **These "Antarctic Challenges" make the continent an analog of Moon and Mars as to the difficulty of setting up Lunar and Martian economies.** If we don't accept the challenge of trying out our proposed ways of "working around the obstacles" posed in Antarctica, both natural and artificial (Treaty), how can we be honest in our dreams and convictions of being able to do so in space? Space enthusiasts of all stripes, who ignore Antarctica and choose not to get involved in that continent's future, do so at their own peril.

Note that there already are two "civilian" settlements in Antarctica

Despite the provisions of the Antarctic Treaty, there are two “settlements” there, **families welcome**, both off-shore, both “grandfathered” – having been established before the present Treaty amendments took effect.

(1) **Villa La Estrellas** (Chile) (below) is one of the main ports of call of Antarctica cruises.



This town was founded in 1984 at 62°12' S, 58°53' W on King George Islands, one of the South Shetland Islands, above the Antarctic Peninsula. It is integrated with the Chilean Eduardo Frei Base, a scientific (meteorological center) and military (air base) station.

The hamlet has 20 prefabricated modules, 14 are **family residences**. It also has a **bank**, post, hospital (one doctor, one nurse), school (15 students) kindergarten, hostel, gym, store/market, local shop, and a church. The post office is also an attraction for tourists and philately enthusiasts that travel to the town to send postcards and letters with an Antarctic postmark. Built for visitors, the "**Polestar**" dormitory has room for 90 people.

There is an aerodrome providing the settlement and other Antarctica bases with several connections, with some 200 flights each season. This also serves the neighboring Russian Bellingshausen Station founded in 1968 just 200 meters away. Further, the station is also connected by unimproved roads to the nearby stations: Chilean Base Presidente Edyardo Frei Montalva, Chinese Great Wall Station, and Uruguayan Artigas Base.

The Antarctic Peninsula and its off shore islands are by far the most condensed cluster of outposts in Antarctica, mostly above the Antarctic Circle. The Antarctic Peninsula and its nearby islands are considered to have the mildest living conditions in Antarctica. The average temperature around the station in the coldest month (August) is -6.8°C (19.76°F), and +1.1°C (34°F) in February, the warmest month. Russian polar residents have nicknamed the Bellingshausen Station "kurort" or "resort."

(2) **Esperanza** (Spanish: "Hope Base") is an Argentine base located in Hope Bay, Trinity Peninsula, Antarctic Peninsula. Built 32 years before Las Estrellas, in 1952, the base houses 55 inhabitants in winter, including 10 **families** and 2 school teachers for a school built in 1977. The site enjoys an arctic tundra climate with one “summer” month when it sometimes gets just above freezing. Esperanza can boast that it is the birthplace of the first person to be born in Antarctica.

Esperanza's 43 buildings offer a combined covered space of 3,744 sq m (40,300 sq ft.) Imported fuel oil is used to produce electricity, but a wind generator was installed in 2008. Research is Esperanza's main product and projects include: Glaciology, Seismology, Oceanography, Coastal Ecology, Biology, Geology and Limnology. However the town's tourist facilities are visited by approximately 1,100 tourists each year!

Expanding this list of just two Settlements – a “match made in heaven” proposal

Picking up and moving your family to Antarctica will appeal to very few people. Yet there will be some, so discouraged by current conditions at home, that might be willing to try something “this new, this far out.

But would there not also be **Eskimo, Inuit, and Samoyed families** in the high Arctic that are willing to resettle along the Antarctic Coast at a few favorable locations, with some level of promised support? There are no Caribou in the Antarctic, but there are seals and plenty of fish. Might resettled arctic families flourish and prosper? Perhaps not at first. The Arctic and

Antarctic are quite different. But I believe that in time, transplanted Arctic peoples could thrive in the Antarctic Peninsula and offshore islands, and maybe elsewhere on the last continent.

An ad hoc conference of the US, Canada, Norway, and Russia, with representatives from the native arctic populations of all of them involved, could pursue this idea. There might be no interest, but that would surprise us. The flame of adventure and pioneering is alive within all peoples. Who else would be as hardy? Corporate partners might be involved, so long as this does not lead to “Company Towns” – a worst possible result. But that is a separate other article for a future issue.

Of course, room must be made for people from other non-arctic populations as well. PK.

Working within the Strictures of the Current Antarctic Treaty

Modifying the Antarctic Treaty Strictures to include a more relaxed zone between 60° South to the Antarctic Circle at 68° 32' would be, to us, the first step towards a “pregnant” solution.] **See Map below.**



Note that there are also several ice-free areas above the Antarctic Circle on the Antarctic Coast below Africa and Australia. That said, **this might be a longer term goal. Our first goal** should be to see what we can do to expand the scope of civilian activities, including families, **under the present language** adopted in Madrid in 1998.

Families, children and other dependents not allowed!

The place to start would be the US stations, which together involve the largest population in Antarctica, if not the majority. Besides the scientists and other researchers themselves, we have many more support personnel who maintain the various stations, vessels, aircraft and other equipment and systems, freeing scientists and researchers to do what they come to do. The Antarctic Treaty may not specifically forbid “dependents.” But there would seem to be no room for them in the US Station support personnel programs.

The USAP – “UNITED STATES ARCTIC PROGRAM”

Guide to Programs/Funding Opportunities: www.usap.gov.usapagov/JobsAndOpportunities/index.cfm?=1

Three corporations are the principal players: **Lockhead-Martin, Gana-A ‘You Service Corporation,** and **GHG Corporation,** all equal opportunity employers: women and minority groups are encouraged to apply. But this does not include children or other dependents. What we have as a result are “artificial communities of transients.” While at US Armed Forces bases, it

is common to have off-base housing for spouses and children, this is not the case at US science stations in Antarctica.

Support personnel are hired for limited tours of duty, and many of the seasonal ones (Antarctic summer) return for repeat tours. For these seasonal people, the perk of having family nearby is not an issue. But what about the smaller core of support positions that must be manned year around? Yes, personnel can be rotated here as well. But might it not be a negotiated perk for long duration, all-season support personnel to have their families on location or nearby? Could not this be a decision for the major contractors involved, rather than for the UPAS? Indeed, should it not be the decision of the personnel involved themselves, so long as this can be managed at the employee's expense?

Tourism discouraged or not allowed

The treaty even discourages "tourism" on the continent. It would be preferable to establish strict guidelines for tourist ventures, rather than forbid them outright. Only the peripheral shipboard tourism in and around the Antarctic Peninsula is now allowed. The places where tourists may set foot on the continent itself are quite limited. Yes, we understand that tourists must not be allowed to interfere with research and researchers. Yet we allow tourists with the White House, in Congress, even in the Pentagon, and do so, with a manageable minimum of interference and inconvenience. There is a time and a place for everything. One should not have to become an inner core member of Greenpeace to have access to Antarctica.

Greenpeace is an activist environmentalist organization that can take pride in some of its achievements – in fighting whaling, and in embarrassing the US to the point of forcing a badly needed cleanup of the McMurdo station premises among its credits. But it should not have Hight Priest privileges anymore than should NASA. Greenpeace deserves much credit for the recent revisions in the Antarctic Treaty. That said, some of those provisions go unnecessarily far, and need to be trimmed back. If we fail to integrate a protected Antarctica into our human world here on Earth, we shall surely fail to extend permanent human civilian presence beyond Earth to other worlds.

Summary

1. We need to make a place for families (one's dependents) in Antarctica so that children can grow up there to become a first native-born generation
2. We need to expand the list of approved activities beyond research and tightly-constrained tourism, to include regulated economic activities that can become a basis for supporting permanent populations while respecting the scenic integrity of this pristine continent.

As on the Moon and Mars, the more people who settle these worlds, the more science and research will get done – by these people and their descendants on location. Humankind is not a cancer on Earth-life. We are the means, the only means, by which Earth-Life can be sown off-world, take root, and flower elsewhere on worlds where life cannot arise on its own. We cannot leave the future of Antarctica, the Moon, Mars and other frontiers to those who understand neither the possibilities of opening these frontiers nor the consequences of not doing so.

We'd like to hear from you

- **Suggest economic activities in Antarctica that could support permanent populations** and at the same time, respect and preserve the environment at large.
- **Suggest ways to open up more of Antarctica while at the same time protecting its treasures**
- **Suggest ways permanent residents might adjust** to very long daylight summers, and dark winters: Note in Alaska, the extreme seasonal lighting variation from very long days and very short nights to very long nights and very short days may be a source of the states very high suicide rate. Some of the ideas we have suggested for future lunans to adjust to long dayspans and nightspans by controlling lighting in indoor and middoor spaces should be applicable.

- Show how your suggestions for Antarctica might help open up the Moon and Mars.
Send to kokhmmm@aol.com or to PO Box 395, Milwaukee, WI 53208 c/o Moon Society



Three Frontiers whose futures are closely linked together – it is up to us!

=====

MMM #256

Antarctic Cottage Industries based on “Found” Objects & Materials

By Peter Kokh

“What is not expressly forbidden, is allowed.” – age old legal maxim

“Mining” implies “excavation” of some kind to provide access to minerals or materials below the surface. This includes “strip mining” or removing of a shallow surface layer to reveal mineral or substance (e.g. coal) just below.

What it does not imply is “collecting” or “gathering” material lying loose on the surface. Collecting meteorites from the surface of Antarctic glaciers is not mining. Neither would be collecting driftwood from other continents tossed up on Antarctic shores by waves and storms. Nor would be salvaging shipwrecks and plane wrecks, or “dumpster diving” the trash piles outside Antarctic stations.

Neither would be collecting crystal rocks lying on the slopes of Mt. Erebus, the continent’s only active volcano, on Ross Island overlooking McMurdo Station. It is 3,794 m, 12,447 ft. high.

<http://skywalker.cochise.edu/wellerr/students/erebus/project.htm>

“Mt. Erebus crystals are also known as anorthoclase feldspar, a type of feldspar that consists of aluminum silicate. ... Rich in sodium, potassium and silicate, there is only one other place on the planet where these crystals can be found, Mt. Kenya, Africa. Crystals grow in the magma beneath Erebus and get spit out of the mountain inside glassy volcanic bombs. The glass quickly weathers away leaving the mountainside covered in crystals. “While not an extraordinary mineral, these are extraordinarily large.” “These crystals are embedded in these bombs and vary in size and shape, but all are of astonishing size for feldspar.”

These crystals are coveted by almost everyone at McMurdo Station.” Gathering these crystals has obviously been tolerated for some time, beginning with Shakleton’s 2009 expedition which found “lumps of lava, large feldspar crystals, from one to three inches in length, and fragments of pumice; both feldspar’ and pumice were in many cases coated with sulfur.”

What can be made from these crystal bearing rocks?

Nothing sparks the artist’s or craftsman’s imagination so much as free material. These crystal bearing volcanic “bombs” come in many sizes and shapes. The writer himself is a long

time scavenger of found and tossed out objects out of which to make something useful. Among my creations are a number of lamps whose bases are found items with minimum modification.



A cottage industry of lamps made from suitable sized Mt Erebus crystals, along with other items made from these found objects could soon give a uniquely Antarctic “feel” to private and public areas of McMurdo Station – and other stations around the continent. Paperweights, ashtrays, bookends. Even countertops.

Anyone who has ever visited Arizona, New Mexico, and other areas of the US southwest is familiar with the special feel created by SouthWest art from Navaho rugs, to adobe construction, and on and on.

Driftwood

Most Antarctic stations are along the coast and on off-shore islands. Wood harvested by storms from shores of South America, Africa, Australia, etc. may occasionally be washed up on Antarctic shores. Many an artist-craftsman has transformed this free material into something useful, or at least decorative.

Shipwrecks and Plane wrecks.

Shipwrecks, when accessible can be sources of useful objects and materials. Add the artist/craftsman magic touch and imagination, and the possibilities are too numerous to list. Wrecked aircraft can yield a lot of scrap metal, as well as some intact items (seats? windows? etc.). The re-use possibilities are endless!

Other possibilities: landscaping, gardening, agriculture

Except along the western shores of the Antarctic Peninsula, there is no plant life in Antarctica. The climate will not support it. What there is, however, moss and lichens, are not to be discounted.



Now imagine a large glassed-in vestibule to an Antarctic Station in which a moderated climate is sustained, warm enough and wet enough to allow a transplanted bed of coastal moss and lichens to thrive, but no warmer, no wetter. It would provide shelter from more severe conditions “outside” and provide a uniquely Antarctic welcome and reassurance. If small planters of moss and/or lichens could survive indoors in private or public areas, such “house plants” might be preferred by some to “exotic” plants from “back home.

At the Amundsen–Scott station at the south pole, there is a much–cherished Food Growth Chamber designed, built, and maintained by the University of Arizona (Tucson) CEAC (Controlled Environment Agriculture Center) – <http://ag.arizona.edu/ceac/> – which we have reported on before. The facility has an antechamber in which station personnel can come and relax, surrounded by living plants. Not only does this facility provide fresh salad stuffs daily, but it provides a significant morale boost. Could not similar aptly sized facilities be provided and maintained by entrepreneurs rather than by hired personnel? Outdoors, there is only sterility.

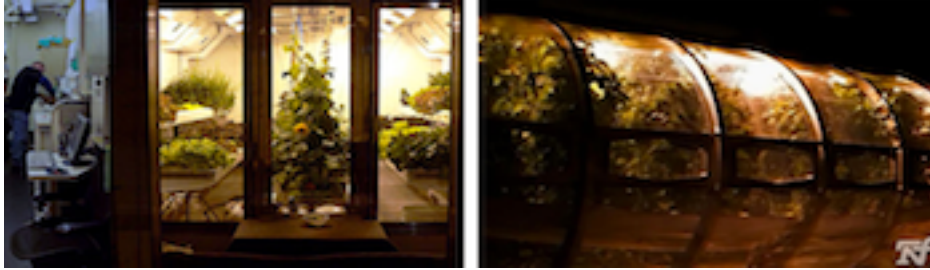

Cottage Industries: from Pastime to Profession

Personnel “allowed” in Antarctica, discounting tourists and visitors, are those hired to assist scientists and researchers and to maintain Antarctic facilities. There would seem to be no place for “entrepreneurs” of any kind. Certainly, there is no place for people who do not earn their right to stay. And clearly, there is no social welfare system on the continent. “Out of work?” – return home, to where you came from!

But it is conceivable that some artist craftsmen could earn the Antarctic equivalent of “full time” income making income and at the same time making it unnecessary to import stock items that their products can supplant. But where would they live? Some stations may have spare space, or unused buildings. If not, maybe if what the artist–craftsman produces is of sufficient value, they could order prefab homes or quarters on mortgage terms. It does not seem likely that even a station as large as McMurdo might someday have an artist–craftsman “suburb” anytime soon. But it would be a start towards a small but growing Antarctic “citizenry.”

Fast forward to Moon and Mars: “earning the right to stay”

Might personnel hired for temporary service at an outpost on Moon and Mars, earn his/her right to stay by providing entrepreneurial service of this or any other kind that helps the outpost grow and thrive? This could be how permanent settlement starts. Beyond arts and crafts produced furniture and furnishings that made it unnecessary to import equivalent items from Earth, entrepreneurs could undoubtedly find many other ways to make themselves useful. It may pay to import the tools and supplies they need to keep improving and adding to the services they offer. And if they stay behind, that saves cost of a return home.

The various national space agencies or collaborations of them, may never recruit “settlers.” It is then up to those hired to work at Lunar and Martian outposts to earn that right in their spare time.

Could this be how settlement starts? Those with side–talents hired to work at Antarctic stations could pave the way and establish a paradigm for the introduction of a “resident population.” All great things can be traced to humble beginnings!

PK

APPENDIX

There are more issues to be addressed.

- 1) **The Moon Treaty has not been signed by the United States, and for good reason.** It does not seem to allow basic property rights. Without alteration, the treaty would disallow

ownership by Individuals, corporations, and even by settlements, putting the Moon in the same legal limbo as Antarctica.

It is one thing to disallow national claims which would, if allowed, “Balkanize” the Moon. It is quite another thing to disallow reasonable property right by settlements, corporations, and individuals.

Those who do not see settlement as economically viable will want to keep the still-unratified treaty as it is. Those of us who see the Moon as Humankind’s Eight Continent must fight approval of this Treaty in its present state.

Modeling the Moon Treaty after the similarly constrictive Law of the Sea treaty, which has effectively discouraged sea-bed mining, would be a mistake.

As we have pointed out in our proposed Lunar National Parks treaty, it is possible to have both settlements and industry and still respect the Moon’s pristine character on the whole.

This is a fight we must not lose.

But if we do, the resulting treaty will be something we must ignore.

There is no better way to force amendments than to ignore undue restrictions. PK

United Nations Trusteeship

An alternative to the Moon Treaty in its unamended state

By Peter Kokh

We propose that a joint trust be established that would include all nations cooperating in one or more **International Lunar Research Parks**. The list of involved nations would include the United States, Russia, European Union, Canada, Japan, China for a start, and take on other countries as they begin to participate. This is somewhat similar to the way nations participating in Antarctic research work together. Those countries choosing not to participate would have no say in guiding pioneer settlements and settlers.

Permanent Settlements (citizens committed to stay X number of years (2?, 3?) having voting rights therein) would remain under Trusteeship supervision until they achieved a healthy state of self-maintenance and growth and a prospering economy. Minimum populations could be set, along with minimum guidelines for export-import balance. But in order not to set the threshold so low as to allow home rule to settlements with minimal populations, levels could be set: one thousand, five thousand, twenty thousand, etc. Those who see such figures as science-fantasy, have no grasp of the Moon’s considerable economic potential as the anchor of a greatly expanded **Earth-Moon Econosphere**.

Read the theme issue: [mmt_LunarEconomy.pdf](#)

When there were a number (3 minimum, the more the better) of such established settlements they should be allowed to establish a global lunar government, under the trusteeship.

At some future time when a positive trade balance had been established and maintained for a minimum number of years, independence should be approved.

A Republic of Luna might wish to belong to UNESCO, a humanitarian and social organization, but not to the United Nations itself, as they should have no say over what goes on here on Earth. PK



In this proposal, the Lunar Currency would be called **the “Tanstaaf!”** after Robert A. Heinlein’s **“There Ain’t No Such Thing As A Free Lunch”** in his classic novel, **“The Moon is a Harsh Mistress.”**